



INTERNATIONAL APPLICATION PUBLISHED UNDER THE PATENT COOPERATION TREATY (PCT)

(51) International Patent Classification <sup>3</sup> : C12N 15/00, 5/00; C12P 21/00 A01B 79/00	A1	(11) International Publication Number: WO 84/ 02920 (43) International Publication Date: 2 August 1984 (02.08.84)
---	----	--

(21) International Application Number: PCT/US84/00050  
 (22) International Filing Date: 16 January 1984 (16.01.84)  
 (31) Priority Application Number: 458,402  
 (32) Priority Date: 17 January 1983 (17.01.83)  
 (33) Priority Country: US  
 (71) Applicant: MONSANTO COMPANY [US/US]: 800 North Lindbergh Boulevard, St. Louis, MO 63167 (US).  
 (72) Inventors: FRALEY, Robert, Thomas : 828 Lisakay Drive, Glendale, MO 63167 (US). HORSCH, Robert, Bruce : 12316 Tempo Drive, St. Louis, MO 63141 (US). ROGERS, Stephen, Gary : 312 Sylvester Avenue, Webster Groves, MO 63119 (US).  
 (74) Agent: BRUSOK, Fabian, A.: 800 North Lindbergh Boulevard, St. Louis, MO 63167 (US).

(81) Designated States: AT (European patent), AU, BE (European patent), CH (European patent), DE (European patent), FR (European patent), GB (European patent), JP, LU (European patent), NL (European patent), SE (European patent).  
 Published  
 With international search report.

A.O.J.P. 13 SEP 1984  
 AUSTRALIAN  
 15 AUG 1984  
 PATENT OFFICE

(54) Title: GENETICALLY TRANSFORMED PLANTS

(57) Abstract  
 Genetically transformed, non-tumorous plant cells. A modified Ti plasmid is created which contains a left T-DNA border, one or more desired genes, and a right T-DNA border. This region does not contain tumorigenic or phytohormone-altering genes. The Ti plasmid is inserted into plant cells, where the T-DNA region is transferred into the plant genome. The transformed plant cells may be regenerated into morphologically normal plants which will pass the desired gene(s) to their descendants.

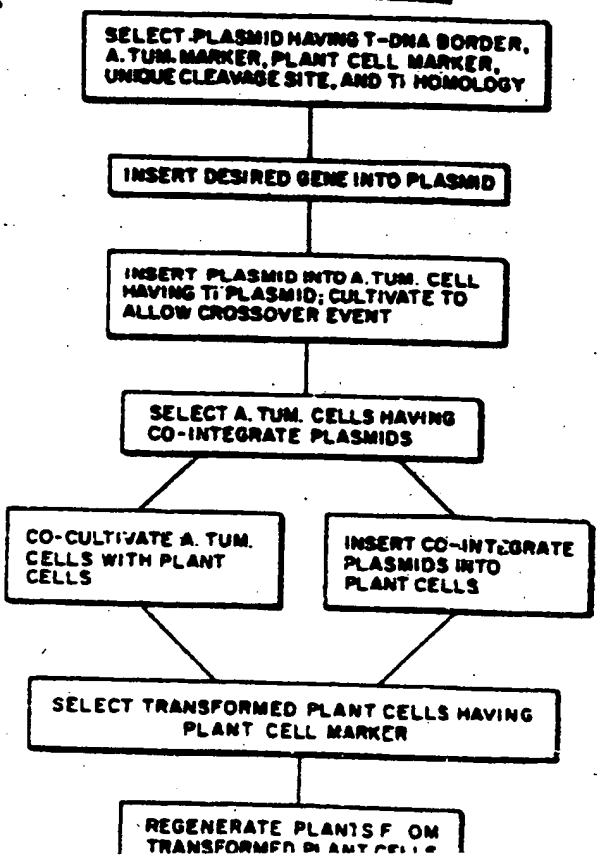

GENETICALLY TRANSFORMED PLANTSTechnical Field

5           This invention is in the fields of genetic engineering, plant biology, and bacteriology.

BACKGROUND ART

10           In the past decade, the science of genetic engineering has developed rapidly. A variety of processes are known for inserting a heterologous gene into bacteria, whereby the bacteria become capable of efficient expression of the inserted genes. Such processes normally involve the use of plasmids which may be cleaved at one or more selected cleavage sites by restriction endonucleases. Typically, a gene of interest is obtained by cleaving one piece of DNA, and the resulting DNA fragment is mixed with a fragment obtained by cleaving a vector such as a plasmid. The different strands of DNA are then connected ("ligated") to each other to form a reconstituted plasmid. See, for example, U.S. Patents 4,237,224 (Cohen and Boyer, 1980); 4,264,731 (Shine, 1981); 4,273,875 (Manis, 1981); 4,322,499 (Baxter et al, 1982), and 4,336,336 (Silhavy et al, 1982).

A variety of other reference works are available. Some of these works describe the natural process whereby DNA is transcribed into mRNA and mRNA is translated into protein, see, 5 e.g., L. Stryer, Biochemistry, 2nd edition, p 559 et seq. (W. H. Freeman and Co., 1981); A. L. Lehninger, Biochemistry, 2nd edition, p. 853 et seq. (Worth Publ., 1975). Other works describe methods and products of genetic manipulation; see, 10 e.g., T. Maniatis et al, Molecular Cloning, A Laboratory Manual (Cold Spring Harbor Labs, 1982); J.K. Setlow and A. Hollaender, Genetic Engineering, Principles and Methods (Plenum Press, 1979). Hereafter, all references will be cited in 15 abbreviated form; a list of complete citations is included after the Examples.

Most of the genetic engineering work 20 performed to date involves the insertion of genes into various types of cells, primarily bacteria such as E. coli, various other microorganisms such as yeast, and mammalian cells. However, many of the techniques and substances used for genetic 25 engineering of animal cells and microorganisms are not directly applicable to genetic engineering involving plants.

As used herein, the term "plant" refers to 30 a multicellular differentiated organism that is capable of photosynthesis, such as angiosperms and multicellular alga. This does not include microorganisms, such as bacteria, yeast, and

fungi. The term "plant cell" includes any cell derived from a plant; this includes undifferentiated tissue such as callus or crown gall tumor, as well as plant seeds, propagules, pollen, or plant embryos.

### Ti and Ri Plasmids

10 The tumor-inducing (Ti) plasmid of Agrobacterium tumefaciens has been proposed for use as a natural vector for introducing foreign genetic information into plant cells (Hernalsteen et al 1980; Rorsch and Schilperoort, 1978).

15 Certain types of A. tumefaciens are capable of infecting a wide variety of plant cells, causing crown gall disease. The process of infection is not fully understood. At least part of the Ti plasmid enters the plant cell. Various metabolic alterations occur, and part of the Ti plasmid is inserted into the genome of the plant (presumably into the chromosomes). The part of the Ti plasmid that enters the plant genome is designated as "transferred DNA" (T-DNA). T-DNA is stably maintained in the plant DNA (Chilton et al, 1977; Yadev et al, 1980; Willmitzer et al, 1980; Otten et al, 1981).

30 Research by several laboratories has led to the characterization of several structural (i.e., protein coding) genes located in T-DNA (Garfinkel et al 1981; Leemans et al 1982), as well as other DNA sequences which appear to serve various other functions. For example, two sequences referred to

as the "left border" and the "right border" appear to delineate T-DNA and may be involved in the process whereby T-DNA is transferred into plant chromosomes (Zambryski et al 1982).

5

A different species of Agrobacterium, A. rhizogenes, carries a "root-inducing" (Ri) plasmid which is similar to the Ti plasmid. Infection of a plant cell by A. rhizogenes causes hairy root disease. Like the Ti plasmid, a segment of DNA called "T-DNA" (also referred to by some researchers as "R-DNA") is transferred into the plant genome of an infected cell.

10

15

Various other bacteria are also reported to be capable of causing genetic transformation of plant cells, including A. rubi and certain bacteria of the genus Rhizobia which have been treated with a mutagenic agent. Hooykaas et al, at page 156 of Setlow and Holsaender, 1979.

20

As used herein, the term "Ti plasmid" includes any plasmid (1) which is contained in a microorganism, other than a virus, which is capable of causing genetic transformation of one or more types of plants or plant cells, and (2) which contains a segment of DNA which is inserted into a plant genome. This includes Ri plasmids.

25

30

As used herein, the term "T-DNA" refers to a segment of DNA in or from a Ti plasmid (1) which has been inserted into the genome of one or more types of plant cells, or (2) which is contained in a segment of DNA that is located between two

sequences of bases which are capable of serving as T-DNA borders. As used herein, the terms "T-DNA border" and "border" are determined and applied empirically; these terms shall refer to a sequence of bases which appears at or near the end of a segment of DNA which is transferred from a Ti plasmid into a plant genome.

Despite the existing knowledge of T-DNA and Ti plasmids, no one prior to this invention has been able to utilize these vectors for the introduction of foreign genes which are expressed in genetically modified plants. A variety of obstacles to such use have been encountered in genetic engineering efforts. Such obstacles include:

1) the large size (approximately 200,000 base pairs) and resulting complexity of Ti plasmids preclude the use of standard recombinant DNA techniques to genetically modify and/or insert foreign genes into specific sites in the T-DNA. For example, there are no known unique restriction endonuclease cleavage sites in a Ti plasmid (Leemans et al, 1982).

2) the T-DNA, which is inserted into and expressed in plant cells, contains genes which are involved in the production of high levels of phytohormones in the transformed plant cells (Leemans et al 1982). The high levels of phytohormones interfere with the normal metabolic and regulatory processes of the cells, and prevent the formation of phenotypically normal plants from

-6-

the cells (Braun and Wood, 1976; Yang et al, 1980). Exceptions to this are rare cases where the T-DNA has undergone extensive spontaneous deletions in planta to eliminate those genes involved in phytohormone production. Under these conditions, normal plants are reported to be obtainable at low frequency (Otten et al, 1981). However, the T-DNA genes involved in phytohormone production could not be deleted prior to this invention, since they were very important in the identification and/or selection of transformed plant cells (Marton et al, 1979).

As described above, simple recombinant DNA techniques for introducing foreign genes into plasmids are not applicable to the large Ti plasmid. As a result, several indirect methods have been developed and are discussed below. The first reported use of the Ti plasmid as a vector was in model experiments in which bacterial transposons were inserted into T-DNA and subsequently introduced into plant cells. The bacterial transposons were reported to be stably maintained in the plant genome (Hernalsteens et al, 1980; Garfinkel et al 1981). However, in these cases the transformed tumor tissues were found to be incapable of regeneration into normal plants, and there was no reported evidence for the expression of bacterial genes in the plant cells. In addition, because the insertion of bacterial transposons is believed to be essentially random, a great deal of effort was required to identify and localize the position of the inserted DNA in these examples. Therefore, this approach is not

likely to be useful to introduce desired genes in a predictable manner into plants.

5 Other researchers have reported the use of intermediate vectors which replicate in both E.coli and A. tumefaciens (Matzke and Chilton, 1981; Leemans et al 1981; Garfinkel et al, 1981). The intermediate vectors contain relatively small subfragments of the Ti plasmid which can be  
10 manipulated using standard recombinant DNA techniques. The subfragments can be modified by the deletion of specific sequences or by the insertion of foreign genes at specific sites. The intermediate vectors containing the modified T DNA subfragment are then introduced into A.  
15 tumefaciens by transformation or conjugation. Double recombination between the modified T-DNA fragment on the intermediate vector and its wild-type counterpart on the Ti plasmid results in the replacement of the wild-type copy with the  
20 modified fragment. Cells which contain the recombined Ti plasmids can be selected using appropriate antibiotics.

25 Various foreign DNA's have been inserted at specific sites in the T-DNA by this method and they have been reported to be stably transferred into plant cells (Matzke and Chilton, 1981, Leemans et al 1981, 1982). However, such foreign  
30 genes have not been reported to be capable of expression in plant cells, and the transformed plant cells remain incapable of regeneration into normal plants. Furthermore, in the procedure described above, it is preferred for a double



5 crossover event to occur, in order to substitute the modified DNA fragment for the wild-type copy. A single crossover results in the formation of a co-integrate plasmid which contains two copies of the T-DNA subfragments. This duplication is undesirable in these methods since homologous recombination, which can occur in A. tumefaciens cells or in plant cells, can result in the loss of the inserted foreign gene(s).

10

A major disadvantage of the above methods is that the frequency of double recombination is quite low, about  $10^{-4}$  to  $10^{-9}$  (Leemans et al, 1981) and it requires extensive effort to identify and isolate the rare double-crossover recombinants. As a result, the number and types of experiments which can be performed using existing methods for genetically engineering the Ti plasmid is severely limited.

15  
20

#### Other Means for Inserting DNA into Plant Cells

25 A variety of other methods have been reported for inserting DNA into plant cells. One such method involves the use of lipid vesicles, also called liposomes, to encapsulate one or more DNA molecules. The liposomes and their DNA contents may be taken up by plant cells; see, e.g., Lurquin, 1981. If the inserted DNA can be incorporated into the plant genome, replicated, and inherited, the plant cells will be transformed.

30

Other alternate techniques involve contacting plant cells with DNA which is complexed with either (a) polycationic substances, such as poly-L-ornithine (Davey et al, 1980), or (b) calcium phosphate (Krens et al, 1982). Using these techniques, all or part of a Ti plasmid has been reportedly inserted into plant cells, causing tumorigenic alteration of the plant cells.

Another method has been developed involving the fusion of bacteria, which contain desired plasmids, with plant cells. Such methods involve converting the bacteria into spheroplasts and converting the plant cells into protoplasts. Both of these methods remove the cell wall barrier from the bacterial and plant cells, using enzymic digestion. The two cell types can then be used together by exposure to chemical agents, such as polyethylene glycol. See Hasezawa et al, 1981.

However, all of the foregoing techniques suffer from one or more of the following problems:

1. transformation efficiencies reported to date have been very low;
2. only small DNA molecules can be inserted into plant cells;
3. only small numbers of DNA molecules can be inserted into plant cells; and/or,
4. a gene which is inserted into a plant cell will not be stably maintained by the plant

cell unless it is incorporated into the genome of the plant cell, i.e., unless the gene is inserted into a chromosome or plasmid that replicates in the plant cell.

5

For these and possibly other reasons, no one has yet reported expression of a gene inserted into a plant cell by any of the foregoing techniques, except for the tumorigenic transformations noted above.

10

Prior to this invention, no satisfactory method existed for the creation and identification of genetically transformed plant cells which could be routinely regenerated into morphologically normal plants.

15

#### SUMMARY OF THE INVENTION

20

This invention relates to a method for transforming plant cells, and to plant cells transformed by this method. This invention also relates to a method for regenerating differentiated plants from transformed plant cells, and to transformed plants.

25

This invention involves a first plasmid, such as pMON120, which has certain desired characteristics described below. A gene which is capable of being expressed in plant cells may be inserted into this plasmid to obtain a derivative plasmid, such as pMON128. For example, plasmid pMON128 contains a chimeric gene which expresses neomycin phosphotransferase II (NPT II), an enzyme

30

-11-

which inactivates certain antibiotics. The chimeric gene is capable of expression in plant cells.

5 The derivative plasmid is inserted into a suitable microorganism, such as Agrobacterium tumefaciens cells which contain Ti plasmids. In the A. tumefaciens cells, some of the inserted plasmids recombine with Ti plasmids to form a co-integrate plasmid; this is due to a region of  
10 homology between the two plasmids. Only a single crossover event is required to create the desired co-integrate plasmid.

15 Because of the characteristics of the inserted plasmid of this invention, the resulting co-integrate Ti plasmid contains the chimeric gene and/or any other inserted gene within the T-DNA region of the co-integrate plasmid. The inserted gene(s) are surrounded by at least two T-DNA  
20 borders, at least one of which was inserted into the Ti plasmid by the crossover event. By means of appropriate antibiotics, A. tumefaciens cells which do not have co-integrate Ti plasmids with inserted genes are killed.

25 A. tumefaciens cells with co-integrate plasmids are co-cultured with plant cells, such as protoplasts, protoplast-derived cells, plant cuttings, or intact plants, under conditions which  
30 allow the co-integrate Ti plasmids, or portions thereof, to enter the plant cells. Once inside the plant cells, a portion of the Ti plasmid which is surrounded by the two T-DNA borders is inserted

-12-

by natural processes into the plant genome. This  
segment of DNA contains the chimeric gene and/or  
any other desired gene(s). Preferably, the  
segment of vector DNA which is inserted into the  
5 plant genome does not contain any genes which  
would render the plant cell incapable of being  
regenerated into a differentiated,  
morphologically-normal plant. The transformed  
plant cell(s) may be regenerated into a  
10 morphologically-normal plant which will pass the  
inserted gene to its descendants.

A variety of uses exist for plants  
transformed by the method of this invention. For  
15 example, a gene which codes for an enzyme  
which inactivates a herbicide may be inserted into  
a plant. This would make the plant and its  
descendants resistant to the herbicide.  
Alternately, a gene which codes for a desired  
20 mammalian polypeptide such as growth hormone,  
insulin, interferon, or somatostatin may be  
inserted into plants. The plants may be grown and  
harvested, and the polypeptide could be extracted  
from the plant tissue.

25

#### BRIEF DESCRIPTION OF THE DRAWINGS

30

FIG. 1 is a flow chart indicating the steps  
of this invention.

FIG. 2 represents the creation of pMON41, a  
plasmid used to construct pMON120.

35

-13-

FIG. 3 represents the creation of M-4, an M13-derived DNA used to construct pMON109.

5 FIG. 4 represents the creation of pMON54, a plasmid used to construct pMON109.

FIG. 5 represents the creation of pMON109, a plasmid used to construct pMON120.

10 FIG. 6 represents the creation of pMON113, a plasmid used to construct pMON120.

15 FIG. 7 represents the creation of plasmid pMON120, an intermediate vector with three restriction endonuclease cleavage sites which are suitable for the insertion of a desired gene.

20 FIG. 8 represents the creation of pMON128, an intermediate vector which was obtained by inserting a chimeric NOS-NPT II kanamycin-resistance gene into pMON120.

25 FIG. 9 represents the cointegration of pMON128 with a wild-type Ti plasmid by means of a single crossover event, thereby creating a co-integrate plasmid with multiple borders.

30 FIG. 10 indicates the co-integration of pMON128 with a disabled Ti-plasmid, thereby creating a non-tumorigenic cointegrate plasmid.

FIG. 11 is a graph comparing growth of transformed cells and non-transformed cells on kanamycin-containing medium.

DETAILED DESCRIPTION OF THE INVENTION

In one preferred embodiment of this invention, a variety of chimeric genes were inserted into plant cells using the steps that are summarized on the flow chart of Figure 1. As shown on Figure 1, three preliminary plasmids were prepared. Those plasmids were designated as:

1. pMON41, which contained a right border from a nopaline-type Ti plasmid, and the 5' portion of a nopaline synthase (NOS) gene. The construction of plasmid pMON41 is described below and shown in Figure 2.

2. pMON109, which contained the 3' portion of a NOS gene, and a selectable marker gene (spc/str) which allowed for the selection of A. tumefaciens cells having co-integrate Ti plasmids with chimeric genes. The construction of plasmid pMON109 is described below and shown in Figures 3, 4, and 5.

3. pMON113, which contained a region of DNA with a sequence that is identical to the sequence within the T-DNA portion of an octopine-type Ti plasmid. This region was designated as the "left inside homology" (LIH) region. The construction of pMON113 is described below and shown in Figure 6.

After these plasmids were assembled, each plasmid was digested by appropriate endonucleases

-15-

to obtain a desired fragment. The fragments  
(one from each of the three plasmids) were  
assembled in a triple ligation to obtain the  
intermediate vector, plasmid pMON120, as shown in  
5 Figure 7.

Plasmid pMON120 plays a key role in the  
embodiment of this invention that is described in  
detail below. This plasmid has the following  
characteristics:

10

1. pMON120 has at least three unique  
restriction endonuclease cleavage sites (EcoRI,  
ClaI, and HindIII) which allow for the convenient  
insertion of any desired gene.

15

2. pMON120 will replicate within normal  
E. coli cells. However, it will not replicate  
within normal Agrobacterium cells unless it  
co-integrates with another plasmid, such as a Ti  
20 plasmid, which will replicate in Agrobacterium  
cells.

20

3. pMON120 carries a marker gene which  
codes for an enzyme which confers resistance to  
two antibiotics, spectinomycin (spc) and  
streptomycin (str). This gene, referred to as the  
spc/str gene, is expressed in E. coli and in A.  
25 tumefaciens, but not in plant cells. pMON120 does  
not carry genes which code for resistance to  
30 ampicillin or tetracycline.

30



4. pMON120 carries a sequence which is homologous to a sequence within the T-DNA portion of an octopine-type Ti plasmid of A. tumefaciens. This sequence is referred to as the "left inside homology" (LIH) region. This region of homology promotes a crossover event whereby pMON120, or a derivative of pMON120 such as pMON128, forms a co-integrate with the Ti plasmid if the two plasmids exist inside the same A. tumefaciens cell. By definition, the "co-integrate" plasmid is formed by a single crossover event. It contains all DNA sequences that previously existed in either the Ti plasmid or the pMON120-derived plasmid.

5. pMON120 carries a nopaline-type T-DNA "right border," i.e., a sequence which is capable of acting as one end (designated by convention as the right border) of a T-DNA sequence which is transferred from a Ti plasmid and inserted into the chromosome of a plant cell during transformation of the cell by A. tumefaciens.

6. pMON120 carries a gene (including a promoter) which codes for the expression of an enzyme, nopaline synthase (NOS). Once introduced into a plant cell, the NOS enzyme catalyzes the production of nopaline, a type of opine. In most types of plants, opines are non-detrimental compounds which accumulate at low levels; the presence of nopaline can be readily detected in plant tissue (Ott and Schilperoort, 1978). Opine genes may serve as useful marker genes to confirm transformation, since opines do not

-17-

normally exist in untransformed plant cells. If desired, the NOS gene in pMON120 may be rendered non-functional by a variety of techniques known to those skilled in the art. For example, a BamHI cleavage site exists within the coding portion of the NOS gene; a stop codon or other appropriate oligonucleotide sequence could be inserted into this site to prevent the translation of NOS.

7. The relative location of the various genes, cleavage sites, and other sequences in pMON120 is very important to the performance of this invention. The entire pMON120 plasmid, or its derivative plasmid such as pMON128, will be contained in the co-integrate Ti plasmid. However, only part of the co-integrate Ti plasmid (the modified T-DNA region) will be inserted into the plant genome. Therefore, only a part of the pMON120-derived plasmid will be inserted into the plant genome. This portion begins at the T-DNA border, and stretches in one direction only to the region of homology. In pMON120, the NOS scorable marker, the spc/str selectable marker, and the three insertion sites are within the portion of pMON120 that would be transferred into the plant genome. However, the pBR322-derived region next to the LIH, and the PvuI cleavage site, probably would not be transferred into the plant genome. Importantly, this arrangement of pMON120 and its derivatives prevents the transfer of more than one region of homology into the plant genome, as discussed below.

8. pMON120 is about 8 kilobases long. This is sufficiently small to allow it to accomplish

-18-

all of the objectives of this invention. However, if desired, it may be made somewhat smaller by the deletion of one or more nucleotide sequences which are not essential, using methods which are known to those skilled in the art. Such a reduction in size might improve the efficiency or other characteristics of the plasmid when used for this invention or for other purposes, as may be determined by those skilled in the art.

It is recognized that a wide variety of intermediate vectors which differ from pMON120 in one or more respects may be prepared and utilized by those skilled in the art. For example, the NOS marker used for scoring transformed plant cells might be deleted, or replaced or supplemented by a different scorable or selectable marker. One such marker gene might comprise an antibiotic-resistance gene such as the NOS-NPT II-NOS chimeric gene described below. As another example, the *spc/str* marker gene used for selecting *A. tumefaciens* cells with co-integrate plasmids might be deleted, or replaced or supplemented by a different scorable or selectable marker that is expressed in *Agrobacteria*. As another example, a variety of T-DNA borders (such as a nopaline-type "left" border, or an octopine-type left or right border) might be utilized. Similarly, more than one border (such as two or more nopaline right borders, or one nopaline right border and one octopine right border) might be inserted into the intermediate vector, in the desired orientation; this may increase the frequency of insertion of the T-DNA into the plant

-19-

genom , as may b determin d by those skilled in the art. It is also possible to insert both left and right borders (of any type) into an intermediate vector. It is also possible to increase the length of the region of homology; this is likely to increase the frequency of the desired single crossover event (Leemans et al, 1981). It is also possible to select an appropriate region of homology from any type of desired plasmid, such as a nopaline or agropine Ti plasmid or an Ri plasmid; such regions will allow the intermediate vector to form a co-integrate with any desired plasmid.

#### Method of Creating pMON120

Plasmid pMON120 was constructed from fragments derived from 3 other plasmids. These three plasmids were designated as pMON41, pMON109, and pMON113. The construction of each of these three plasmids is summarized below; additional information is provided in the examples.

Plasmid pMON41 contributed a nopaline-type T-DNA right border and the 5' portion of a nopaline synthase (NOS) gene to pMON120. It was created by the following method.

A nopaline-type Ti plasmid, designated as the pTiT37 plasmid, may be dig st d with the HindIII ndonuclease to produc a vari ty of fragments, including a 3.4 kb fragment which is designat d as the HindIII-23 fragment. This

fragment contains the entire NOS gene and the T-DNA right border. The Applicants inserted a HindIII-23 fragment into a plasmid, pBR327 (Soberon et al, 1980), which had been digested with HindIII. The resulting plasmid, designated as pMON38, was digested with both HindIII and BamHI. This produced a 2.3 kb fragment which contains the nopaline-type right border and the 5' portion of a NOS gene (including the promoter region, the 5' non-translated region, and part of the structural sequence). This 2.3 kb fragment was inserted into a pBR327 plasmid which had been digested with HindIII and BamHI. The resulting plasmid was designated as pMON41, as shown in Figure 2.

A variety of strains of A. tumefaciens are publicly available from the American Type Culture Collection (Rockville, MD); accession numbers are listed in any ATCC catalog. Each strain contains a Ti plasmid which is likely to be suitable for use in this invention, as may be determined through routine experimentation by those skilled in the art.

Plasmid pMON109 contributed a spc/str selectable marker gene and the 3' portion of a NOS gene to pMON120. It was created by the following method.

Plasmid pMON38 (described above and shown on Figure 2) was digested with RsaI, which creates blunt ends as shown: 5'-GTAC

CATG

-21-

A 1.1 kb fragment was isolated, and digested with BamHI to obtain fragments of 720 bp and 400 bp, each of which had one blunt Rsa end and a cohesive BamHI end. These fragments were added to double stranded DNA from a phage M13 mp8 (Messing and Vieira, 1982) which had been digested with SmaI (which creates blunt ends) and BamHI. The mixture was ligated, transformed into cells and plated for recombinant phage. Recombinant phage DNA's which contained the inserted 720 bp fragment were identified by the size of the BamHI-SmaI insert. One of those phage DNA's was designated as M-4, as shown in Figure 3. The 720 bp insert contained the 3' non-translated region (including the poly-adenylation signal indicated in the figures by a heavy dot) of the NOS gene, as well as the 3' portion of the structural sequence of the NOS gene. The 720 bp insert is surrounded in M-4 by EcoRI and PstI cleavage sites, which were present in the M13 mp8 DNA.

A bacterial transposon, designated as Tn7, is known to contain the spc/str gene, mentioned previously. The Tn7 transposon also contains a gene which causes the host cell to be resistant to the antibiotic trimethoprim. The exact location and orientation of the spc/str gene and the trimethoprim-resistance gene in Tn7, are not known. The Tn7 transposon may be obtained from a variety of cell strains which are publicly available. A strain of A. tumefaciens was isolated in which the Tn7 transposon had been inserted into the Hind III-23 region of a pTi37 plasmid. The modified pTi37 plasmid was

-22-

designated as pGV3106 (Hernalsteens et al, 1980).

Plasmid pGV3106 was digested with HindIII, and the fragments were shotgun-cloned into pBR327 plasmids which had been digested with HindIII. These plasmids were inserted into E. coli cells, and cells which were ampicillin-resistant (due to a pBR327 gene) and trimethoprim-resistant (due to a Tn7 gene) were selected. The plasmid obtained from one colony was designated as pMON31. This plasmid contained a 6kb HindIII insert. The insert contained the spc/str-resistance gene and trimethoprim-resistance gene from Tn7, and the 3' portion of a NOS gene (which came from the pTiT37 plasmid).

Plasmid pMON31 was reduced in size twice. The first reduction was performed by digesting the plasmid with EcoRI, diluting the mixture to remove an 850 bp fragment, and religating the large fragment. The resulting plasmid, designated as pMON53, was obtained from transformed cells selected by their resistance to ampicillin and streptomycin. Resistance to trimethoprim was not determined.

Plasmid pMON53 was further reduced in size by digesting the plasmid with ClaI, diluting the mixture to remove a 2 kb fragment, and religating the large fragment. The resulting 5.2 kb plasmid was designated as pMON54, as shown in Figure 4. This plasmid contains the spc/str gen .

Plasmid pMON54 was digested with EcoRI and

PstI, and a 4.8 kb fragment containing the spc/str gene was isolated. M-4 DNA was digested with EcoRI and PstI, and a 740 bp fragment containing the NOS 3' non-translated region was isolated.

5 These fragments were ligated together to form pMON64. In order to be able to obtain the NOS 3' portion and the spc/str gene on a single EcoRI-BamHI fragment, the orientation of the spc/str gene was reversed by digesting pMON64 with  
10 ClaI and religating the mixture. Plasmids having the desired orientation were identified by cleavage using EcoRI and BamHI. These plasmids were designated as pMON109, as shown in Figure 5.

15 Plasmid pMON113 contributed a region of homology to pMON120 which allows pMON120 to form a co-integrate plasmid when present in A. tumefaciens along with a Ti plasmid. The region of homology was taken from an octopine-type  
20 Ti plasmid. In the Ti plasmid, it is located near the left T-DNA border, within the T-DNA portion of the Ti plasmid. This region of homology is designated as the "left inside homology" (LIH) region.

25 A region of homology may be derived from any type of plasmid capable of transforming plant cells, such as any Ti plasmid or any Ri plasmid. An intermediate vector can be designed which can  
30 form a co-integrate plasmid with whatever type of plasmid the region of homology was derived from.

In addition, it might not be necessary for the region of homology to be located within the



-24-

T-DNA. For example, it may be possible for a region of homology to be derived from a segment of a Ti plasmid which contains a T-DNA border and a sequences of bases outside of the T-DNA region.

5 Indeed, if the intermediate vector contains two appropriate T-DNA borders, it might be possible for the region of homology to be located entirely outside of the T-DNA region.

10 The Applicants obtained an E. coli culture with a pBR-derived plasmid containing the Bam-8 fragment of an octopine-type Ti plasmid. The Bam-8 fragment, which is about 7.5 kb, contains the left border and the LIH region of the Ti  
15 plasmid (Willmitzer et al, 1982; DeGreve et al, 1981). The Bam-8 fragment was inserted into the plasmid pBR327, which had been digested with BamHI. The resulting plasmid was designated as pMON90, as shown in Figure 6.

20 Plasmid pMON90 was digested with BglII, and a 2.6 kb fragment which contains the LIH region but not the left border was purified. The 2.6 kb fragment was treated with Klenow polymerase,  
25 to convert the cohesive ends into blunt ends, and the fragment was digested with HindIII to obtain a 1.6 kb fragment (the desired fragment) and a 1 kb fragment. Both fragments were mixed with a pBR322 plasmid which had been digested with PvuII and  
30 HindIII. The mixture was ligated, and inserted into E. coli cells. The cells were selected for ampicillin resistance, and scored for the presence of a SmaI site which exists on the 1.6 kb fragment but not the 1 kb fragment. A colony having the

desired plasmid was identified, and the plasmid from this colony was designated as pMON113, as indicated by Figure 6.

5 To assemble pMON120, three fragments had to be isolated. Plasmid pMON41 was digested with PvuI and BamI, and a 1.5 kb fragment containing a nopaline-type right border and the 5' portion of a NOS gene was isolated. Plasmid pMON109 was  
10 digested with BamHI and EcoRI, and a 3.4 kb fragment containing a spc/str gene and the 3' part of a NOS gene was isolated. Plasmid pMON113 was digested with PvuI and EcoRI, and a 3.1 kb fragment containing the LIH region was isolated.

15 The three fragments were mixed together and ligated to form pMON120, as shown on Figure 7. A culture of E. coli containing pMON120 has been deposited with the American Type Culture Collection. This culture has been assigned accession number  
20 39263.

It is recognized that a variety of different methods could be used to create pMON120,  
25 or any similar intermediate vector. For example, instead of the triple ligation, it would have been possible to assemble two of the desired fragments in a plasmid, and insert the third fragment into the plasmid.

30

#### Method of Using pMON120

As mentioned previously, pMON120 has three

unique cleavage sites (EcoRI, ClaI, and HindIII) which are suitable for the insertion of any desired gene. These cleavage sites are located in the portion of pMON120 that will be inserted into a plant genome, so the inserted gene also will be inserted into the plant genome.

A variety of chimeric genes which are capable of expressing bacterial and mammalian polypeptides in plant cells have been created by the Applicants. These chimeric genes are described in detail in a separate application entitled "Chimeric Genes Suitable for Expression in Plant Cells," copending U.S. application serial number 458,414, filed on January 17, 1983.

Those chimeric genes are suitable for use in this invention. They may be inserted into pMON120 to create a derivative plasmid, which may be utilized as described below.

In one preferred embodiment of this invention, a chimeric gene was created which comprises the following DNA sequences:

1. a promoter region and a 5' non-translated region derived from a nopaline synthase (NOS) gene;

2. a structural sequence derived from a neomycin phosphotransferase II (NPT II) gene; and

3. a 3' non-translated region derived from a NOS gen .

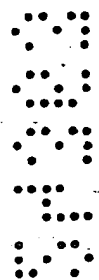

-27-

This chimeric NOS-NPT II-NOS gene was isolated on a DNA fragment having EcoRI ends. This fragment was inserted into the EcoRI cleavage site of pMON120, and the resulting plasmids (having chimeric gene inserts with opposite orientations) were designated as pMON128 and pMON129, as shown in Figure 8. Plasmid pMON129 has two copies of the chimeric gene; this may be a useful feature in certain types of work. Either plasmid may be utilized to transform plant cells, in the following manner. A culture of E. coli containing pMON128 has been deposited with the American Type Culture Collection. This culture has been assigned accession number 39264.

Plasmid pMON128 (or any other plasmid derived by inserting a desired gene into pMON120) is inserted into a microorganism which contains an octopine-type Ti plasmid (or other suitable plasmid). Suitable microorganisms include A. tumefaciens and A. rhizogenes which carry Ti or Ri plasmids. Other microorganisms which might also be useful for use in this invention include other species of Agrobacterium, as well as bacteria in the genus Rhizobia. The suitability of these cells, or of any other cells known at present or hereafter discovered or created, for use in this invention may be determined through routine experimentation by those skilled in the art.

The plasmid may be inserted into the microorganism by any desired method, such as

BUREAU

transformation (i.e., contacting plasmids with cells that have been treated to increase their uptake of DNA) or conjugation with cells that contain the pMON128 or other plasmids.

5

The inserted plasmid (such as pMON128) has a region which is homologous to a sequence within the Ti plasmid. This "LH" region of homology allows a single crossover event whereby pMON128 and an octopine-type Ti plasmid combine with each other to form a co-integrate plasmid. See, e.g., Stryer, supra, at p. 752-754. Normally, this will occur within the A. tumefaciens cell after pMON128 has been inserted into the cell. Alternately, the co-integrate plasmid may be created in a different type of cell or in vitro, and then inserted into an A. tumefaciens or other type of cell which can transfer the co-integrate plasmid into plant cells.

15  
20

The inserted plasmid, such as pMON128, combines with the Ti plasmid in the manner represented by Figures 9 or 10, depending upon what type of Ti plasmid is involved.

25

In Figure 9, item 2 represents the T-DNA portion of an octopine-type Ti plasmid. Item 4 represents the inserted plasmid, such as pMON128. When these two plasmids co-exist in the same cell, a crossover event can occur which results in the creation of co-integrate plasmid 6.

30

Co-int grat plasmid 6 has one left border 8, and two right borders 10 and 12. The two right

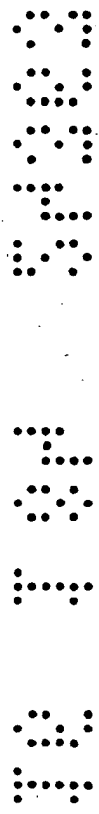

borders are designated herein as the "proximal" right border 10 (the right border closest to left border 8), and the "distal" right border 12 (the right border that is more distant from left border 8). Proximate right border 10 was carried by plasmid 4; the distal right border was contained on Ti plasmid 2 before co-integration.

A culture of A. tumefaciens GV3111 containing a co-integrate plasmid formed by pMON128 and wild-type Ti plasmid pTiB653 has been deposited with the American Type Culture Collection. This culture has been assigned accession number 39266.

When co-integrate Ti plasmid 6, shown in Figure 9, is inserted into a plant cell, either of two regions of DNA may enter the plant genome, T-DNA region 14 or T-DNA region 16.

T-DNA region 14 is bounded by left border 8 and proximate right border 10. Region 14 contains the chimeric gene and any other genes contained in plasmid 4, such as the *spc/str* selectable marker and the NOS scorable marker. However, region 14 does not contain any of the T-DNA genes which would cause crown gall disease or otherwise disrupt the metabolism or regenerative capacity of the plant cell.

T-DNA region 16 contains left border 8 and both right borders 10 and 12. This segment of T-DNA contains the chimeric gene and any other genes contained in plasmid 4. However, T-DNA region 16

-30-

also contains the T-DNA genes which are believed to cause crown gall disease.

5           Either of the foregoing T-DNA segments, Region 14 or Region 16, might be transferred to the plant DNA. This is presumed to occur at a 50-50 probability for any given T-DNA transfer. This is likely to lead to a mixture of transformed cells, some of which are tumorous and some or  
10           which are non-tumorous. It is possible to isolate and cultivate non-tumorous cells from the mixture, as described in the examples.

15           An alternate approach has also been developed which avoids the need for isolating tumorous from non-tumorous cells. Several mutant strains of A. tumefaciens have been isolated which are incapable of causing crown gall disease. Such strains are usually referred to as "disarmed" Ti  
20           plasmids. A Ti or Ri plasmid may be disarmed by one or more of the following types of mutations:

1. Removal or inactivation of one of the border regions. One such disarmed octopine  
25           plasmid, which has a left border but not a right border, is designated as pAL4421; this plasmid is contained in A. tumefaciens strain LBA4421 (Ooms et al, 1982; Carfinkel et al, 1981).

30           2. Removal or inactivation of the one or more of the "tumor morphology" genes, designated as the *tmr* and *tms* genes. See, e.g., Leemans et al, 1982.

Various other types of disarmed Ti plasmids may be prepared using methods known to those skilled in the art. See Matzke and Chilton, 1981; Leemans et al, 1981; Koekman et al, 1979.

5

Figure 10 represents an octopine-type Ti plasmid with a T-DNA region 22 which undergoes mutation to delete the *tms* and *tmr* genes and the right border. This results in a disarmed Ti plasmid with partial T-DNA region 24. When plasmid 26 (such as pMON128) is inserted into a cell that carries the disarmed Ti plasmid 24, a crossover event occurs which creates a co-integrate Ti plasmid with disarmed T-DNA region 28. The LTR region of homology is repeated in this Ti plasmid, but the disarmed Ti plasmid does not contain any oncogenic genes. Alternately, if only the right border had been deleted from T-DNA region 22, then the *tms* and *tmr* genes and the octopine synthase (OCS) gene would be contained in the co-integrate disarmed Ti plasmid; however, they would have been located outside of the T-DNA borders.

10

15

20

25

30

35

The disarmed co-integrate Ti plasmid is used to infect plant cells, and T-DNA region 28 enters the plant genome, as shown by transformed DNA 30. Plant cells transformed by disarmed T-DNA 28 have normal phytohormone metabolism, and normal capability to be regenerated into differentiated plants.

After pMON128 is inserted into A. tumefaciens cells, the desired crossover event



-32-

will occur in a certain fraction of the cells. Cells which contain co-integrated plasmids (whether virulent or disarmed) may be easily selected from other cells in which the crossover did not occur, in the following manner. Plasmid pMON120 and its derivatives contain a marker gene (spc/str), which is expressed in A. tumefaciens. However, these plasmids do not replicate in A. tumefaciens. Therefore, the spc/str marker gene will not be replicated or stably inherited by A. tumefaciens unless the inserted plasmid combines with another plasmid that can replicate in A. tumefaciens. The most probable such combination, due to the region of homology, is the co-integrate formed with the Ti plasmid. A. tumefaciens cells which contain this co-integrate plasmid can readily be identified and selected by growth of the cells on medium containing either spc or str, or both.

The Ti plasmid 28, shown in Figure 10, contains two LIH regions. It is possible that co-integrated Ti plasmids will undergo a subsequent crossover event, wherein the two LIH regions will recombine. This event is undesirable, since it can lead to a deletion of the DNA between the LIH regions, including the chimeric gene. However, this is not likely to lead to serious difficulties, for two reasons. First, this event is likely to occur at a relatively low probability, such as about  $10^{-2}$ . Second, plasmid pMON120 and its derivatives have been designed so that the selectable marker gene (spc/str) is located in the region of DNA that would be deleted by the crossover event. Therefore, the selective

-33-

conditions that are used to identify and culture Agrobacterium cells containing co-integrate plasmids will also serve to kill the descendants of cells that undergo a subsequent crossover event which eliminates the chimeric gene from the Ti plasmid.

Only one of the LIH regions in the co-integrate Ti plasmid will be inserted into the plant genome, as shown in Figure 10. This important feature results from the design of pMON120, and it distinguishes this co-integrate plasmid from undesired co-integrate plasmids formed by the prior art. The LIH region which lies outside of the T-DNA borders will not be inserted into the plant genome. This leads to at least two important advantages. First, the presence of two LIH regions inserted into the plant genome could result in crossover events which would lead to loss of the inserted genes in the transformed plant cells and their progeny. Second, the presence of two regions of DNA homology can significantly complicate efforts to analyze the DNA inserted into the plant genome (Matzke and Chilton, 1981).

After Agrobacterium tumefaciens cells which contain the co-integrate Ti plasmids with the chimeric genes have been identified and isolated, the co-integrate plasmids (or portions thereof) must be inserted into the plant cells. Eventually, methods may be developed to perform this step directly. In the meantime, a method has been developed which may be used conveniently and with

good results. This method is described in two separate copending U.S. patent applications, entitled "Transformation of Plant Cells by Extended Bacterial Co-Cultivation" serial number 458,413, and "Rapid Culture of Plant Protoplasts," serial number 458,412, both of which were filed on January 17, 1983.

The method described in those applications may be briefly summarized as follows.

The plant cells to be transformed are contacted with enzymes which remove the cell walls. This converts the plant cells into protoplasts, which are viable cells surrounded by membranes. The enzymes are removed, and the protoplasts begin to regenerate cell wall material. At an appropriate time, the A. tumefaciens cells (which contain the co-integrate Ti plasmids with chimeric genes) are mixed with the plant protoplasts. The cells are co-cultivated for a period of time which allows the A. tumefaciens to infect the plant cells. After an appropriate co-cultivation period, the A. tumefaciens cells are killed, and the plant cells are propagated.

Plant cells which have been transformed (i.e., cells which have received DNA from the co-integrate Ti plasmids) and their descendants may be selected by a variety of methods, depending upon the type of gene(s) that were inserted into the plant genome. For example, certain genes may cause various antibiotics to be inactivated; such

-35-

genes include the chimeric NOS-NPT II-NOS gene carried by pMON128. Such genes may serve as selectable markers; a group of cells may be cultured on medium containing the antibiotic which is inactivated by the chimeric gene product, and only those cells containing the selectable marker gene will survive.

A variety of genes may serve as scorable markers in plant cells. For example, pMON120 and its derivative plasmids, such as pMON128, carry a nopaline synthase (NOS) gene which is expressed in plant cells. This gene codes for an enzyme which catalyzes the formation of nopaline. Nopaline is a non-detrimental compound which usually is accumulated at low quantities in most types of plants; it can be easily detected by electrophoretic or chromatographic methods.

If a plant is transformed by a gene which creates a polypeptide that is difficult to detect, then the presence of a selectable marker gene (such as the NOS-NPT II-NOS chimeric gene) or a scorable marker gene (such as the NOS gene) in the transforming vector may assist in the identification and isolation of transformed cells.

If desired, appropriate incantations may be recited at any time during the performance of this invention. The effects of such incantations upon the methods, substances, or cells of this invention are not fully understood. However, such incantations are believed to perform an important role in enhancing the awareness and appreciation

of scientific and other personnel for the  
 importance of this invention and the steps  
 involved therein. A wide variety of incantations  
 are known to those skilled in the art; the choice  
 5 of incantation(s) for use with any particular  
 method, compound, or type of cell may be  
 determined by personal preference. Such  
 incantations may, if desired, be supplemented or  
 replaced by a variety of other communicative  
 10 methods and devices.

Virtually any desired gene may be inserted  
 into pMON120 or other plasmids which are designed  
 15 to form co-integrates with Ti or similar plasmids.  
 For example, the Applicants have created a variety  
 of chimeric genes, which are discussed in the  
 previously-cited application, "Chimeric Genes  
 Suitable for Expression in Plant Cells."  
 20

The suitability of any gene for use in this  
 invention may be determined through routine  
 experimentation by those skilled in the art. Such  
 usage is not limited to chimeric genes; for  
 25 example, this invention may be used to insert  
 multiple copies of a natural gene into plant  
 cells.

This invention is suitable for use with a  
 30 wide variety of plants, as may be determined  
 through routine experimentation by those skilled  
 in the art. For example, this invention is likely  
 to be useful to transform cells from any type of

plant which can be infected by bacteria from the  
genus Agrobacterium. It is believed that  
virtually all dicotyledonous plants, and certain  
monocots, can be infected by one or more strains  
5 of Agrobacterium. In addition, microorganisms of  
the genus Rhizobia are likely to be useful for  
carrying co-integrate plasmids of this invention,  
as may be determined by those skilled in the art.  
Such bacteria might be preferred for certain types  
10 of transformations or plant types.

Certain types of plant cells can be  
cultured in vitro and regenerated into  
differentiated plants using techniques known to  
those skilled in the art. Such plant types  
15 include potatoes, tomatoes, carrots, alfalfa and  
sunflowers. Research in in vitro plant culture  
techniques is progressing rapidly, and methods are  
likely to be developed to permit the regeneration  
of a much wider range of plants from cells  
20 cultured in vitro. Cells from any such plant with  
regenerative capacity are likely to be  
transformable by the in vitro co-cultivation  
method discussed previously, as may be determined  
through routine experimentation by those skilled  
25 in the art. Such transformed plant cells may be  
regenerated into differentiated plants using the  
procedures described in the examples.

30  
The in vitro co-cultivation method offers  
certain advantages in the transformation of plants  
which are susceptible to in vitro culturing and  
regeneration. However, this invention is not

limited to in vitro cell culture methods. For  
exampl , a variety of plant shoots and cuttings  
(including soybeans, carrots, and sunflowers) have  
been transformed by contact with A. tumefaciens  
5 cells carrying the co-integrate plasmids of this  
invention. It is also possible to regenerate  
virtually any type of plant from a cutting or  
shoot. Therefore, it may be possible to develop  
methods of transforming shoots or cuttings using  
10 virulent or preferably disarmed co-integrate  
plasmids of this invention or mixtures thereof,  
and subsequently regenerating the transformed  
shoots or cuttings into differentiated plants  
which pass the inserted genes to their progeny.

15

As mentioned previously, it is not  
essential to this invention that co-cultivation be  
utilized to transfer the co-integrate plasmids of  
this invention into plant cells. A variety of  
20 other methods are being used to insert DNA into  
cells. Such methods include encapsulation of DNA  
in liposomes, complexing the DNA with chemicals  
such as polycationic substances or calcium  
phosphate, fusion of bacterial spheroplasts with  
25 plant protoplasts, microinjection of DNA into a  
cell, and induction of DNA uptake by means of  
-electric current. Although such methods have not  
been used to insert DNA into plant cells with  
satisfactory efficiency to date, they are being  
30 actively researched and they may be useful for  
inserting foreign genes into plant cells, using  
the intermediate vectors and co-integrate plasmids  
of this invention, or plasmids derived therefrom.

This invention may be useful for a wide variety of purposes. For example, certain bacterial enzymes, such as 5-enol pyruvyl shikimate-3-phosphoric acid synthase (EPSP synthase) are inactivated by certain herbicides; other enzymes, such as glutathione-S-transferase (GST), inactivate certain herbicides. It may be possible to insert chimeric genes into plants which will cause expression of such enzymes in the plants, thereby causing the plants to become resistant to one or more herbicides. This would allow for the herbicide, which would normally kill the untransformed plant, to be applied to a field of transformed plants. The herbicide would serve as a weed-killer, leaving the transformed plants undamaged.

Alternately, it may be possible to insert chimeric genes into plants which will cause the plants to create mammalian polypeptides, such as insulin, interferon, growth hormone, etc. At an appropriate time, the plants (or cultured plant tissue) would be harvested. Using a variety of processes which are known to those skilled in the art, the desired protein may be extracted from the harvested plant tissue.

An alternate use of this invention is to create plants with high content of desired substances, such as storage proteins or other proteins. For example, a plant might contain one or more copies of a gene which codes for a desirable protein. Additional copies of this gene may be inserted into the plant by means of this



invention. Alternately, the structural sequence of the gen might be inserted into a chimeric gene under the control of a different promoter which causes prolific transcription of the structural sequence.

5

The methods of this invention may be used to identify, isolate, and study DNA sequences to determine whether they are capable of promoting or otherwise regulating the expression of genes within plant cells. For example, the DNA from any type of cell can be fragmented, using partial endonuclease digestion or other methods. The DNA fragments can be inserted randomly into plasmids similar to pMON128. These plasmids, instead of having a full chimeric gene such as NOS-NPT II-NOS, will have a partial chimeric gene, with a cleavage site for the insertion of DNA fragments, rather than a NOS promoter or other promoter. The plasmids with inserted DNA are then inserted into A. tumefaciens, where they can recombine with the Ti plasmids. Cells having co-integrate plasmids are selected by means of the spc/str or other marker gene. The co-integrate plasmids are then inserted into the plant cells, by bacterial co-cultivation or other means. The plant cells will contain a selectable marker structural sequence such as the NPT II structural sequence, but this structural sequence will not be transcribed unless the inserted DNA fragment serves as a promoter for the structural sequence. The plant cells may be select d by growing them on m dium containing kanamycin or other appropriate antibiotics.

10

15

20

25

30

35

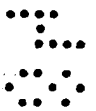
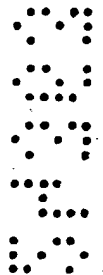

-41-

Using this method, it is possible to evaluate the promoter regions of bacteria, yeast, fungus, algae, other microorganisms, and animal cells to determine whether they function as gene promoters in various types of plant cells. It is also possible to evaluate promoters from one type of plant in other types of plant cells. By using similar methods and varying the cleavage site in the starting plasmid, it is possible to evaluate the performance of any DNA sequence as a 5' non-translated region, a 3' non-translated region, or any other type of regulatory sequence.

As used herein, "a piece of DNA" includes plasmids, phages, DNA fragments, and polynucleotides, whether natural or synthetic.

As used herein, a "chimeric piece of DNA" is limited to a piece of DNA which contains at least two portions (i.e., two nucleotide sequences) that were derived from different and distinct pieces of DNA. For example, a chimeric piece of DNA cannot be created by merely deleting one or more portions of a naturally existing plasmid. A chimeric piece of DNA may be produced by a variety of methods, such as ligating two fragments from different plasmids together, or by synthesizing a polynucleotide wherein the sequence of bases was determined by analysis of the base sequences of two different plasmids.

As used herein, a chimeric piece of DNA is limited to DNA which has been assembled, synthesized, or otherwise produced as a result of

man-made efforts, and any piece of DNA which is replicated or otherwise derived therefrom.

"Man-made efforts" include enzymatic, cellular, and other biological processes, if such processes occur under conditions which are caused, enhanced, or controlled by human effort or intervention; this excludes plasmids, phages, and

polynucleotides which are created solely by natural processes. As used herein, the term

"derived from" shall be construed broadly.

Whenever used in a claim, the term "chimeric" shall be a material limitation.

As used herein, "foreign" DNA includes any DNA which is inserted into a pre-existing plant cell. A "foreign gene" is a gene which is inserted into a pre-existing plant cell.

As used herein, a "marker gene" is a gene which confers a phenotypically identifiable trait upon the host cell which allows transformed host cells to be distinguished from non-transformed cells. This includes screenable, scorable, and selectable markers.

As used herein, a "region of homology" refers to a sequence of bases in one plasmid which has sufficient correlation with a sequence of bases in a different plasmid to cause recombination of the plasmid to occur at a statistically determinable frequency. Preferably, such recombination should occur at a frequency which allows for the convenient selection of cells having combined plasmids, e.g., greater than 1 per

-43-

$10^6$  cells. This term is described more fully in a variety of publications, e.g., Leemans et al, 1981.

5                    Those skilled in the art will recognize, or  
 be able to ascertain using no more than routine  
 experimentation, numerous equivalents to the  
 specific embodiments of the invention discussed  
 herein. Such equivalents are within the scope of  
 10 this invention.

#### EXAMPLES

##### Example 1: Creation of Plasmid pMON41

15                    A culture of E. coli, carrying a  
 pBR325 plasmid (Bolivar, 1978) with the HindIII-23  
 fragment of pTiT37 (Hernalsteens, et al, 1980)  
 inserted at the HindIII site, was obtained from  
 20 Drs. M. Bevan and M.D. Chilton, Washington  
 University, St. Louis, MO. Ten micrograms (ug) of  
 the plasmid from this clone was digested with 10  
 units of HindIII (unless noted, all restriction  
 endonucleases used in these constructions were  
 25 purchased from New England Biolabs, Beverly, MA  
 and used with buffers according to the supplier's  
 instructions) for 1 hour at 37°C. The 3.4 kb  
 HindIII-23 fragment was purified by adsorption on  
 glass beads (Vogelstein and Gillespie, 1979) after  
 30 separation from the other HindIII fragments by  
 electrophoresis on a 0.8% agarose gel. The  
 purified 3.4 kb HindIII fragment (1.0 ug) was  
 mixed with 1.0 ug of plasmid pBR327 DNA (Soberon,  
 et al, 1980) that had been digested with both

-44-

HindIII (2 units, 1 hour, 37°C and calf alkaline phosphatase (CAP; 0.2 units, 1 hour, 37°C de-proteinized with phenol, ethanol precipitated, and resuspended in 10 ul of TE (10 mM Tris HCl, 5 pH8, 1 mM EDTA). One unit of T4 DNA ligase (prepared by the method of Murray et al, 1979) was added to the fragment mixture. One unit is defined as the concentration sufficient to obtain greater than 90% circularization of one microgram 10 of HindIII linearized pBR327 plasmid in 5 minutes at 22°C. The mixed fragments were contained in a total volume of 15 ul of 25 mM Tris-HCl pH8, 10 mM MgCl<sub>2</sub>, 1 mM dithiothreitol, 200 uM spermidine HCl and 0.75 mM ATP (ligase buffer).

15

The mixture was incubated at 22°C for 3 hours and then mixed with E. coli C600 recA56 cells that were prepared for transformation by treatment with CaCl<sub>2</sub> (Maniatis et al, 1982).

20

Following a period for expression of the ampicillin resistance determinant carried by the pBR327 vector, cells were spread on LB solid medium plates (Miller, 1972) containing ampicillin at 200 ug/ml. After incubation at 37°C for 16 25 hours, several hundred clones were obtained.

25

Plasmid mini-preps (Ish-Horowicz and Burke, 1981) were performed on 24 of these colonies and aliquots of the plasmid DNA's obtained (0.1 ug) were digested with HindIII to demonstrate the 30 presence of the 3.4 kb HindIII fragment. One plasmid demonstrated the expected structure and was designated pMON38. pMON38 DNA were prepared by Triton X-100 lysis and CsCl gradient procedure (Davis t al, 1980).

30

-45-

Fifty ug of pMON38 DNA were digested with HindIII and BamHI (50 units each, 2 hours, 37°C and the 2.3 kb HindIII-BamHI fragment was purified as described above. The purified fragment (1 ug) was mixed with 1 ug of the 2.9 kb HindIII-BamHI fragment of the pBR327 vector purified as described above. Following ligation (T4 DNA ligase, 2 units) and transformation of E. coli cells as described above, fifty ampicillin-resistant colonies were obtained. DNAs from twelve plasmid mini-preps were digested with HindIII and BamHI to ascertain the presence of the 2.3 kb fragment. One plasmid of the correct structure was chosen and designated pMON41, as shown in Figure 2. A quantity of this DNA was prepared as described above.

Example 2: Creation of M13 Clone M-4

Thirty ug of plasmid pMON38 (described in Example 1) were digested with RsaI (30 units, 2 hours, 37°C and the 1100 bp RsaI fragment was purified after separation by agarose gel electrophoresis using the glass bead method described in the previous example. The purified 1100 bp RsaI-RsaI fragment (1 ug) was digested with 2 units of BamHI and the BamHI was inactivated by heating. This DNA was mixed with 0.2 ug of phage M13mp8RF DNA which had been previously digested with SmaI and BamHI (2 units each, 1 hour, 37°C and 0.2 units of calf alkaline phosphatase (CAP). Following ligation with 100 units of T4 DNA ligase, transformation of E. coli

-46-

JM101 cells as described in the previous example, the transformed cells were mixed with soft agar and plated under conditions that allow the identification of recombinant phage (Messing and Vieira, 1982). Twelve recombinant phage producing cells were picked and RF plasmid mini-preps were obtained as described in the previous example. The RF DNAs were digested with BamHI and SmaI to prove the presence of the 720 bp RsaI-BamHI fragment. One of the recombinant RF DNAs carrying the correct fragment was designated M13 mp8 M-4. This procedure is represented in Figure 3. M-4 RF DNA was prepared using the procedures of Ish-Horowitz and Burke, 1981 and Colman et al, 1978.

### Example 3: Construction of pMON109

Twenty ug of plasmid pGV3106 (Hernalsteens et al. 1980, prepared by the method of Currier and Nester 1976) was digested with HindIII (20 units, 2 hours, 37°C and mixed with 2 ug of HindIII-digested pBR327. Following ligation (T4 DNA ligase, 2 units) and transformation of E. coli cells as described above, one colony resistant to trimethoprim (100 ug/ml) and ampicillin was obtained. Digestion of plasmid DNA from this cell demonstrated the presence of a 6 kb HindIII fragment. This plasmid was designated pMON31.

Plasmid pMON31 from a mini-prep (0.5 ug) was digested with EcoRI (1 unit, 1 hour, 37°C) and the endonuclease was inactivated by heating (10

min, 70°C). The 8.5 kb plasmid fragment was  
recircularized in a ligation reaction of 100 ul  
(T4 DNA ligase, 1 unit) and used to transform E.  
coli cells with selection for ampicillin and  
5 streptomycin (25 ug/ml) resistant colonies.  
Plasmid mini-prep DNA's from six clones were  
digested with EcoRI to ascertain loss of the 850  
bp fragment. One plasmid lacking the 850 bp EcoRI  
10 fragment was designated pMON53. This plasmid was  
introduced into E. coli GM42 dam- cells (Bale et  
al, 1979) by transformation as described.

Plasmid pMON53 (0.5 ug) from a mini-prep  
15 prepared from dam- cells was digested with ClaI,  
and recircularized in dilute solution as described  
above. Following transformation of E. coli GM42  
cells and selection for ampicillin and  
spectinomycin (50 ug/ml) resistant clones, fifty  
colonies were obtained. Digestion of plasmid  
20 mini-prep DNA's from six colonies showed that all  
lacked the 2 kb ClaI fragment. One of these  
plasmids was designated pMON54, as represented in  
Figure 4. Plasmid DNA was prepared as described  
in Example 1.

Plasmid pMON54 DNA (20 ug) was digested  
25 with EcoRI and PstI (20 units of each, 2 hours,  
37°C) and the 4.8 kb fragment was purified from  
agarose gels using NA-45 membrane (Schleicher and  
Schuell, Keene, N.H.).

30 The purified 4.8 kb fragment (0.5 ug) was  
mixed with 0.3 ug of a 740 bp EcoRI-PstI fragment  
obtained from M13mp8 M-4 RF DNA (described in



Exempl 2) which was purified using NA-45  
membrane. Following ligation (T4 DNA ligase, 2  
units), transformation of E. coli GM42 dam- cells,  
and selection for spectinomycin resistant cells,  
5 twenty colonies were obtained. Plasmid mini-prep  
DNA's prepared from twelve of these clones were  
digested with PstI and EcoRI to demonstrate the  
presence of the 740 bp fragment. One plasmid  
carrying this fragment was designated pMON64. A  
10 quantity of this plasmid DNA was prepared as  
described in Example 1.

DNA (0.5 ug) of pMON64 was digested with  
ClaI (1 unit, 1 hour, 37°C), the ClaI was heat  
15 inactivated, and the fragments rejoined with T4  
DNA ligase (1 unit). Following transformation  
and selection for spectinomycin resistant cells,  
plasmid mini-preps from twelve colonies were  
made. The DNA's were digested with BamHI and  
20 EcoRI to determine the orientation of the 2 kb  
ClaI fragment. Half of the clones contained the  
ClaI fragment in the inverse orientation of that  
in pMON64. One of these plasmids was designated  
pMON109, as represented in Figure 5. DNA was  
25 prepared as described in Example 1.

Example 4: Creation of plasmid pMON113

30 Plasmid pNW31C-8,29C (Thomashow et al,  
1980) was obtained from Dr. S. Gelvin of Purdue  
University, West Lafayette, IN. This plasmid  
carries th pTiA6 7.5 kb Bam-8 fragment. The  
Bam-8 fragment was purified from 50 ug of

-49-

BamHI-digested pNW31C-8,29C using NA-45 membrane as described in previous examples. The purified 7.5 kb Bam-8 fragment (1.0 ug) was mixed with 0.5 ug of pBR327 vector DNA which had been previously digested with both BamHI (2 units) and 0.2 units of calf alkaline phosphatase (CAP) for 1 hour at 37°C the mixture was deproteinized and resuspended as described in previous examples. The mixed fragments were treated with T4 ligase (2 units), used to transform E. coli C600 recA cells and ampicillin-resistant colonies were selected as described previously. Mini-preps to obtain plasmid DNA were performed on twelve of these clones. The DNA was digested with BamHI to demonstrate the presence of the pBR327 vector and 7.5 kb Bam-8 fragments. One plasmid demonstrating both fragments was designated pMON90. DNA was prepared as described in Example 1.

Twenty-five ug of pMON90 DNA were digested with BglII (25 units, 2 hours, 37°C and the 2.6 kb BglII fragment was purified using NA-45 membrane. To create blunt ends, the fragment (2 ug) was resuspended in 10 ul of 50 mM NaCl, 6.6 mM Tris-HCl pH8, 6.6 mM MgCl<sub>2</sub> and 0.5 mM dithiothreitol (Klenow Buffer). The 4 deoxy-nucleoside triphosphates (dATP, dTTP, dCTP, and dGTP) were added to a final concentration of 1 mM and one unit of E. coli large Klenow fragment of DNA polymerase I (New England Biolabs, Beverly, MA) was added. After incubation for 20 minutes at 22°C, the Klenow polymerase was heat inactivated and 10 units of HindIII was added. The HindIII digestion was carried out for 1 hour at 37°C and

th n the enzym was heat inactivated. The  
HindIII-BglII (blunt) fragments (1 ug) were added  
to 0.25 ug of the 2.2 kb HindIII-PvuII fragment of  
pBR322 (Bolivar, et al, 1977) which had been  
5 generated by HindIII and PvuII digestion then  
treating with calf alkaline phosphatase as  
described in previous examples. After ligation  
using 100 units of T4 DNA ligase, transformation  
of E. coli LE392 cells and selection of  
10 ampicillin-resistant colonies as described in  
previous examples, nineteen colonies were  
obtained. Plasmid mini-preps were prepared from  
twelve colonies and digested with HindIII to  
determine the size of the recombinant plasmid and  
15 with SmaI to determine that the correct fragment  
had been inserted. One plasmid with the correct  
structure was designated pMON113, as shown in  
Figure 6. Plasmid DNA was prepared as described  
in Example 1.

20

#### Example 5: Creation of Plasmid pMON120

25 Twenty ug of plasmid pMON109 (described in  
Example 3) were digested with EcoRI and BamHI (20  
units each, 2 hours, 37°C) and the 3.4 kb  
BamHI-EcoRI fragment was purified using NA-45  
membrane as described in previous examples.  
30 Twenty ug of plasmid pMON41 (described in Example  
1) were digested with BamHI and PvuI (20 units  
each, 2 hours, 37°C) and the 1.5 kb BamHI-PvuI  
fragment purified using NA-45 membrane as  
described in previous examples.

-51-

Twenty ug of pMON113 DNA (described in Example 4) were digested with PvuI and EcoRI (2 units each, 2 hr, 37°C) and the 3.1 kb PvuI-EcoRI fragment was purified using NA-45 membrane as above. To assemble plasmid pMON120, the 3.1 kb EcoRI-PvuI pMON113 fragment (1.5 ug) was mixed with 1.5 ug of the 3.4 kb EcoRI-BamHI fragment from pMON109. After treatment with T4 ligase (3 units) for 16 hours at 10°C, the ligase was inactivated by heating (10 minutes, 70°C and 5 units of BamHI was added. Digestion continued for 30 minutes at 37°C at which time the BamHI endonuclease was inactivated by heating as above. Next, 0.75 ug of the 1.5 kb PvuI-BamHI fragment from pMON41 was added along with T4 DNA ligase (2 units) and fresh ATP to 0.75 mM final concentration. The final ligase reaction was carried out for 4 hours at 22°C at which time the mixture was used to transform E. coli LE 392 cells with subsequent selection for spectinomycin resistant cells as described previously. Plasmid mini-preps from twelve out of several thousand colonies were screened for plasmids of approximately 8 kb in size containing single sites for BamHI and EcoRI. One plasmid showing the correct structure was designated pMON120, which is shown in Figure 7 with an alternate method of construction. pMON120 DNA was prepared as described in Example 1.

A culture of E. coli containing pMON120 has been deposited with the American Type Culture Collection. This culture has been assigned accession number 39263.

Example 6: Creation of Plasmids pMON128 and  
pMON129

5 Plasmid pMON75 (described in detail in a  
separate application entitled "Chimeric Genes  
Suitable for Expression in Plant Cells,"  
previously cited) contains a chimeric NOS-NPT  
II-NOS gene. This plasmid (and pMON128,  
10 described below) may be digested by EcoRI  
and a 1.5 kb fragment may be purified which  
contains the NOS-NPT II-NOS gene.

15 Plasmid pMON120 was digested with EcoRI  
and treated with calf alkaline phosphatase. After  
phenol deproteinization and ethanol precipitation,  
the EcoRI-cleaved pMON120 linear DNA was mixed  
with 0.5 ug of the 1.5 kb EcoRI chimeric gene  
fragment from pMON75 or 76. The mixture was  
20 treated with 2 units of T4 DNA ligase for 1 hour  
at 22°C. After transformation of E. coli cells and  
selection of colonies resistant to spectinomycin  
(50 ug/ml), several thousand colonies appeared.  
Six of these were picked, grown, and plasmid  
mini-preps made. The plasmid DNA's were digested  
25 with EcoRI to check for the 1.5 kb chimeric gene  
insert and with BamHI to determine the orientation  
of the insert. BamHI digestion showed that in  
pMON128 the chimeric gene was transcribed in the  
same direction as the intact nopaline synthase  
30 gene of pMON120. A culture of E. coli containing  
pMON128 has been deposited with the American Type  
Culture Collection. This culture has been  
assigned accession number 39264. The orientation  
of the insert in pMON129 was opposite that in

pMON128; the appearance of an additional 1.5 kb BamHI fragment in digests of pMON129 showed that plasmid pMON129 carried a tandem duplication of the chimeric NOS-NPT II-NOS gene, as shown in Figure 8.

Example 7: Creation of Co-integrate Plasmid

pMON128::pTiB6S3TraC

Plasmid pMON128 (described in Example 6) was transferred to a chloramphenicol resistant Agrobacterium tumefaciens strain GV3111-C58C1 carrying Ti plasmid pTiB6S3tra<sup>C</sup> (Leemans, et al, 1982) using a tri-parental plate mating procedure, as follows. 0.2 ml of a culture of E. coli carrying pMON128 was mixed with 0.2 ml of a culture of E. coli strain HB101 carrying a pRK2013 plasmid (Ditta, et al, 1980) and 0.2 ml of GV3111 cells. The mixture of cells was cultured in Luria Broth (LB), spread on an LB plate, and incubated for 16 to 24 hours at 30°C to allow plasmid transfer and generation of co-integrate plasmids. The cells were resuspended in 3 ml of 10 mM MgSO<sub>4</sub> and 0.2 ml aliquot was then spread on an LB plate containing 25 ug/ml chloramphenicol and 100 ug/ml each of spectinomycin and streptomycin. After incubation for 48 hr at 30°C approximately 10 colonies were obtained. One colony was chosen and grown at 30°C in LB medium containing chloramphenicol, spectinomycin, and streptomycin at the concentrations given above.

A separate type of co-integrate plasmid

-54-

for use in control experiments was prepared by inserting pMON120 into *A. tumefaciens* cells, and selecting for cells with co-integrate plasmids using spectinomycin and streptomycin, as described above. Like pMON120, these plasmids do not contain the chimeric NOS-NPT II-NCS gene.

Example 8: Solutions Used in Plant Cell Cultures

The following solutions were used by the Applicants:

		<u>per liter</u>	
15	Enzyme mix:	Cellulysin	5 g
		Macerozyme	0.7 g
		Ampicillin	0.4 g
		$\text{KH}_2\text{PO}_4$	27.2 mg
20		$\text{KNO}_3$	101 mg
		$\text{CaCl}_2$	1.48 g
		$\text{MgSO}_4 \cdot 7\text{H}_2\text{O}$	246 mg
		KI	0.16 mg
		$\text{CuSO}_4 \cdot 5\text{H}_2\text{O}$	0.025 mg
25		Mannitol	110 g
	MS9:	MS salts(see below)	4.3 g
		Sucrose	30.0 g
		B5 vitamins (see below)	1 ml
30		Mannitol	90.0 g
		Phytohormones:	
		Benzyladenine (BA)	0.5 mg
		2,4-D	1 mg
	MS-ES	MS salts	4.3 g
35		Sucrose	30 g
		B5 Vitamins	1 ml
		Mannitol	30 g
		Carbenicillin	10 mg
		Phytohormones:	
40		Indol acetic acid	0.1 mg

-55-

	MSO:	MS salts	4.3 g
		Sucros	30.0 g
		B5 vitamins	1 ml
5	Feeder plate medium:	MS salts	4.3 g
		Sucrose	30.0 g
		B5 vitamins	1 ml
		Mannitol	30.0 g
10		Phytohormones:	
		BA	0.5 mg
	Ms2C	MS salts	4.3 g
		Sucrose	30 g
		B5 vitamins	1 ml
15		Phytohormones:	
		chlorophenoxyacetic acid	2 mg
	MS104:	MS salts	4.3 g
20		Sucrose	30.0 g
		B5 vitamins	1 ml
		Phytohormones:	
		BA	0.1 mg
25		NAA	1 mg
	MS11:	MS salts	4.3 g
		Sucrose	30.0 g
		B5 vitamins	1 ml
		Phytohormones:	
30		Zeatin	1 mg
	B5 Vitamin stock:	myo-inositol	100 g
		thiamine HCl	10 g
35		nicotinic acid	1 g
		pyrodoxine HCl	1 g
	Float rinse:	MS salts	0.43 g
		Sucrose	171.2 g
40		PVP-40	40.0 g

MS salts are purchased pre-mixed as a dry powder  
from Gibco Laboratories, Grand Island, N.Y.

#### 45 Example 9: Preparation of Protoplasts

Mitchell petunia plants were grown in  
growth chambers with two or three banks of



fluorescent lamps and two banks of incandescent  
bulbs (about 5,000 lux). The temperature was  
maintained at a constant 21°C and the lights were  
on for 12 hours per day. Plants were grown in a  
5 50/50 mix of Vermiculite and Pro-mix BX (Premier  
Brands Inc., Canada). Plants were watered once a  
day with Hoagland's nutrient solution. Tissue was  
taken from dark green plants with compact, bushy  
growth. Leaves were sterilized in a solution of  
10 10% commercial bleach and a small amount of  
detergent or Tween 20 for 20 minutes with  
occasional agitation. Leaves were rinsed two or  
three times with sterile distilled water. Thin  
strips (about 1 mm) were cut from the leaves,  
15 perpendicular to the main rib. The strips were  
placed in the enzyme mix at a ratio of about 1 g  
tissue to 10 ml enzymes. The dishes were sealed  
with parafilm, and incubated in the dark or under  
low, indirect light while gently agitating  
20 continuously (e.g., 40 rpm on gyrotary shaker).  
Enzymic incubations generally were run overnight,  
about 16-20 hours.

The digestion mixture was sieved through a  
25 68, 74, or 88 um screen to remove large debris and  
leaf material. The filtrate was spun at 70-100 g  
for five minutes to pellet the protoplasts. The  
supernatant was decanted and the pellet was gently  
resuspended in float rinse solution. This  
30 suspension was poured into babcock bottles. The  
bottles were filled to 2 or 3 cm above the base of  
the neck. 1 ml of growth medium MS9 was carefully  
layered on top of the float rinse.

-57-

The Babcock bottles were balanced and centrifuged at 500 to 1000 rpm for 10 to 20 minutes. The protoplasts formed a compact band in the neck at the interface. The band was removed with a pipette, taking care not to pick up any excess float rinse. The protoplasts were diluted into MS9. At this point, the protoplasts were washed with MS9 or diluted for plating without washing.

Protoplasts were suspended in MS9 medium at  $5 \times 10^4$  per ml, and plated into T-75 flasks, at 6 ml per flask. Flasks were incubated on a level surface with dim, indirect light or in the dark at 26-28°C. On the third day following the removal of the enzymes from the leaf tissue, MS0 (medium which does not contain mannitol) was added to each flask, using an amount equal to one-half the original volume. The same amount of MS0 is added again on day 4. This reduces the mannitol concentration to about 0.33 M after the first dilution, and about 0.25 M after the second dilution.

#### Example 10: Co-cultivation with Bacteria

On day 5 following protoplast isolation, five to seven day old tobacco suspension cultures (TXD cells) were diluted (if necessary) with MS2C medium to the point where 1 ml would spread easily over the surface of agar medium in a 100 x 15 mm petri plate. This is a 10 to 15% suspension (w/v). The agar medium was obtained by mixing 0.8% agar with MS-ES medium, autoclaving the

-58-

mixtur , and cooling the mixture until it  
solidifies in the plate. One ml of the TXD  
suspension was spread over 25 ml of feeder plate  
medium. An 8.5 cm disc of Whatman #1 filter paper  
5 was laid over the TXD feeder cells and smoothed  
out. A 7 cm disc of the same paper was placed in  
the center of the larger one.

10 Separately, aliquots of a culture of A.  
tumefaciens cells (grown in yeast extract peptone  
medium) were added to the flasks which contained  
the plant cells. One set of aliquots contained  
cells with the pMON128::Ti co-integrate plasmids  
having chimeric NOS-NPT II-NOS genes. The other  
15 set of aliquots contained cells with the  
pMON120::Ti co-integrate plasmids, which do not  
have chimeric NOS-NPT II-NOS genes.

20 The bacteria were added to the flasks to a  
density of  $10^8$  cells/ml. 0.5 ml of the cell  
mixture was spread in a thin layer on the surface  
of the 7 cm filter paper disc. The plates were  
wrapped in parafilm or plastic bags and incubated  
under direct fluorescent lighting, no more than  
25 five plates in a stack.

30 Within seven days, colonies were  
discernable. Within 14 days, the 7 cm discs, with  
colonies adhering to them, were transferred to new  
MSO agar medium (without feeder cells) containing  
500 ug/ml carbenicillin, as well as 50 ug/ml of  
kanamycin sulfate (Sigma, St. Louis, MO). Within  
two weeks, vigorously growing green colonies could  
be observed on the plates which contained plant

cells that had been co-cultured with A. tumefaciens strains containing the pMON128 co-integrate NOS-NPT II plasmid. No transformed colonies were detected on plates which contained plant cells that had been co-cultured with A. tumefaciens strains containing the pMON120 co-integrate plasmid. The kanamycin resistant transformants are capable of sustained growth in culture medium containing kanamycin. Southern blotting experiments (as described in E. Southern, J. Mol. Biol. 98: 503 (1975) confirmed that these cells contain the chimeric NOS-NPT II gene.

Both sets of transformed cells (and a third set of cells which had been transformed in the same manner by a chimeric gene coding for the enzyme NPT type I) were assayed for resistance to kanamycin. The results are indicated in Figure 11.

#### Example 11: Regeneration of Transformed Plants

The transformed kanamycin-resistant colonies described in Example 10 contained both tumorous and non-tumorous cells, as described in Figure 9 and the related text. The following procedure was used to isolate non-tumorous transformed cells from tumorous transformed cells, and to regenerate differentiated plant tissue from the non-tumorous cells.

Colonies were grown on MS104 agar medium containing 30 ug/ml kanamycin sulfate and 500

ug/ml carbenicillin until they reached about 1 cm  
in diameter. Predominantly tumorous colonies  
appear a somewhat paler shade of green and are  
more loosely organized than predominantly  
5 non-tumorous colonies were removed from the MS104  
medium by tweezers and placed upon MS11 medium  
containing 30 ug/ml kanamycin and 500 ug/ml  
carbenicillin. As the colonies continued to grow,  
colonies that appeared pale green and loosely  
10 organized were removed and discarded.

MS11 medium contains zeatin, a phytohormone  
which induces shooting formation in non-tumorous  
colonies. Several shoots were eventually observed  
15 sprouting from kanamycin-resistant colonies.  
These shoots may be grown to a desired size, and  
cut off by a sharp blade, and inserted into agar  
medium without phytohormones, such as MS0, where  
it may generate roots. If desired, the medium may  
20 be supplemented by naphthalene acetic acid to  
induce rooting. The plants may be grown to a  
desired size in the agar medium, and then  
transferred into soil. If properly cultivated,  
such plants will grow to maturity and generate  
25 seed. The acquired trait will be inherited by  
progeny according to classic Mendelian genetics.

References:

- 30 A. Bale et al, Mut. Res. 59: 157 (1979)  
F. Bolivar, Gene 4: 121 (1978)

- A. Braun and H. Wood, Proc. Natl. Acad. Sci. USA 73: 496 (1976)
- M. D. Chilton et al, Cell 11: 263 (1977)
- 5 A. Colman et al, Eur. J. Biochem 91: 303-310 (1978)
- T. Currier and E. Nester, J. Bact. 126: 157 (1976)
- M. Davey et al, Plant Sci. Lett. 18: 307 (1980)
- R. W. Davis et al, Advanced Bacterial Genetics Cold Spring Harbor Laboratory, New York, (1980)
- 10 H. De Greve et al, Plasmid 6: 235 (1981)
- G. Ditta et al, Proc. Natl. Acad. Sci. USA 77: 7347 (1980)
- D. Garfinkel et al, Cell 27: 143 (1981)
- S. Hasezawa et al, Mol. Gen. Genet. 182: 206 (1981)
- 15 J. Hernalsteens et al, Nature 287: 654 (1980)
- D. Ish-Horowicz and J. F. Burke, Nucleic Acids Res. 9: 2989-2998 (1981)
- B. Koekman et al, J. Bacteriol. 141: 129 (1979)
- 20 F. Krens et al, Nature 296: 72 (1982)

- J. Leemans et al, J. Mol. Appl. Genet. 1: 149  
(1981)
- J. Leemans et al, The EMBO J. 1: 147 (1982)
- 5 A. L. Lehninger, Biochemistry, 2nd ed. (Worth  
Publ., 1975)
- P. Lurquin, Nucleic Acids Res. 6: 3773 (1979)
- T. Maniatis et al, Molecular Cloning, A Laboratory  
Manual (Cold Spring Harbor Labs, 1982)
- L. Marton et al, Nature 277: 129 (1979)
- 10 T. Matzke and M-D Chilton, J. Mol. Appl. Genet. 1:  
39 (1981)
- J. Messing et al, Nucleic Acids Res. 9: 309 (1981)
- J. Messing and J. Vieira, Gene 19: 269-276 (1982)
- J. Miller, Experiments in Molecular Genetics, Cold  
15 Spring Harbor Laboratory, N.Y. (1972)
- N. Murray et al, J. Mol. Biol. 132: 493 (1979)
- G. Ooms et al, Plasmid 7: 15 (1982)
- L. Otten and R. Schilperoort, Biochim. Biophys  
Acta 527: 497 (1978)
- 20 L. Otten, Mol. Gen. Genet. 183: 209 (1981)
- R. Roberts, Nucleic Acids Res. 10: r117 (1982)
- A. Rorsch and R. Schilperoort, Genetic  
Engineering, 189 Elsevier/North Holland, N.Y.  
(1978)
- 25 J. K. Setlow and A. Hollaender, Genetic  
Engineering, Principles and Methods (Plenum Press  
1979)
- X. Soberon et al, Gene 9: 287 (1980)
- L. Stryer, Biochemistry, 2nd. ed. (W. H. Freeman  
and Co., 1981)
- 30 M. Thomashow et al, Cell 19: 729 (1980)
- B. Vogelstein and D. Gillespie, Proc. Natl. Acad.  
Sci.: 615-619 (1979)

- L. Willmitz et al, Nature 287: 359 (1980)
- L. Willmitzer et al, The EMBO J 1: 139 (1982)
- N. Yadev et al, Nature 287: 1 (1980)
- F. Yang et al, Mol. Gen. Genet. 177: 707 (1980)
- 5 P. Zambryski et al, J. Mol. Appl. Genet. 1: 361 (1982)

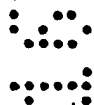
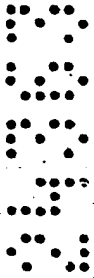



The claims defining the invention are as follows:

1. A method of creating transformed plant cells, comprising the following steps:

5 a) culturing a microorganism containing a first plasmid  
containing at least one first gene that is expressed  
in plant cells and at least one second gene which  
serves as a marker in a selected microorganism and  
a Ti second plasmid, under conditions which allow  
the first plasmid to recombine with the Ti second  
plasmid in the microorganism, thereby creating a  
third plasmid having at least one T-DNA border on  
each side of the first genes, said genes being located  
in said first plasmid between a region of homology  
from the T-DNA region of the Ti plasmid and a T-DNA  
border;

5 b) selecting those microorganisms containing the third  
plasmid;

c) inserting the third plasmid, or a portion thereof,  
into plant cells; and

d) culturing the plant cells under conditions which  
allow a segment of DNA from the third plasmid to  
be inserted into the genome of the plant cells.

2. A method of Claim 1 wherein the third plasmid is a co-  
integrate plasmid formed by a single crossover event  
between the first and second plasmids.

3. A method of Claim 1 or 2 wherein the first gene comprises  
a promoter region derived from a gene which is expressed in  
a plant cell, coupled to a structural sequence which is  
heterologous with respect to the promoter region.

4. A method of any one of Claims 1 to 3 wherein the first plasmid does not autonomously replicate in the selected microorganisms.
5. A method of any one of Claims 1 to 4 wherein the microorganism is selected from the group consisting of Agrobacterium tumefaciens, Agrobacterium rhizogenes, and Agrobacterium rubi.
6. A method of any one of Claims 1 to 5 wherein the third plasmid, or a portion thereof, is inserted into the plant cells by co-cultivating the microorganism with the plant cells.
7. A method of any one of Claims 1 to 6 wherein the Ti second plasmid is a derivative of a tumor-inducing plasmid, from which one or more of the following nucleotide sequences have been deleted:
  - a) a sequence capable of acting as a T-DNA border sequence;
  - b) a "tumor-morphology-shooting" sequence; or
  - c) a "tumor-morphology-rooting" sequence.
8. A method of any one of Claims 1 to 7 wherein the first gene is expressed in plant cells into polypeptides which catalyze the detoxification of one or more phytotoxic substances.
9. A method of any one of Claims 1 to 8 wherein the transformed plant cells are capable of being regenerated into morphologically normal plants.
10. A method of any one of Claims 1 to 9 wherein the transformed plant cells are phenotypically identical to untransformed plant cells with the exception of the ability to express one or more genes that were contained on the first plasmid.

11. A method of any one of Claims 1 to 10 wherein the transformed plant cells are not tumorous.

12. A method of any one of Claims 1 to 10 wherein the transformed plant cells have non-tumorous phytohormone characteristics.

13. A method of transforming plant cells, comprising inserting into the plant cells a co-integrate plasmid, or a portion thereof, which was formed by a single cross-over event between a first plasmid and a Ti second plasmid, wherein the co-integrate plasmid contains a region comprising:

- a) a first T-DNA border;
- b) a gene which is expressed in plant cells; and
- c) a second T-DNA border which is complementary to the first T-DNA border,

wherein the region does not contain any sequences which would render the plant cells incapable of being regenerated into morphologically normal plants.

14. A method of Claim 13, wherein the co-integrate plasmid contains a gene which is capable of serving as a marker gene in the plant cells.

15. Plant cells transformed by the method of any one of Claims 1 to 12 which contain a foreign gene which is expressed.

16. Plant cells transformed by the method of Claim 3 which contain a foreign gene which is expressed.

17. Plant cells transformed by the method of Claim 13 or 14 which contain a foreign gene which is expressed.

18. Morphologically normal plants which express one or more foreign genes produced by the method of any one of Claims 1 to 14.

19. A method of creating transformed plant cells or plants as claimed in Claim 1 or 13, respectively, substantially as described herein.

DATED this 23rd day of December A.D. 1986

MONSANTO COMPANY,  
By its Patent Attorney,



.....  
EDWIN F. WELLINGTON

Fellow of the Institute of  
Patent Attorneys of Australia

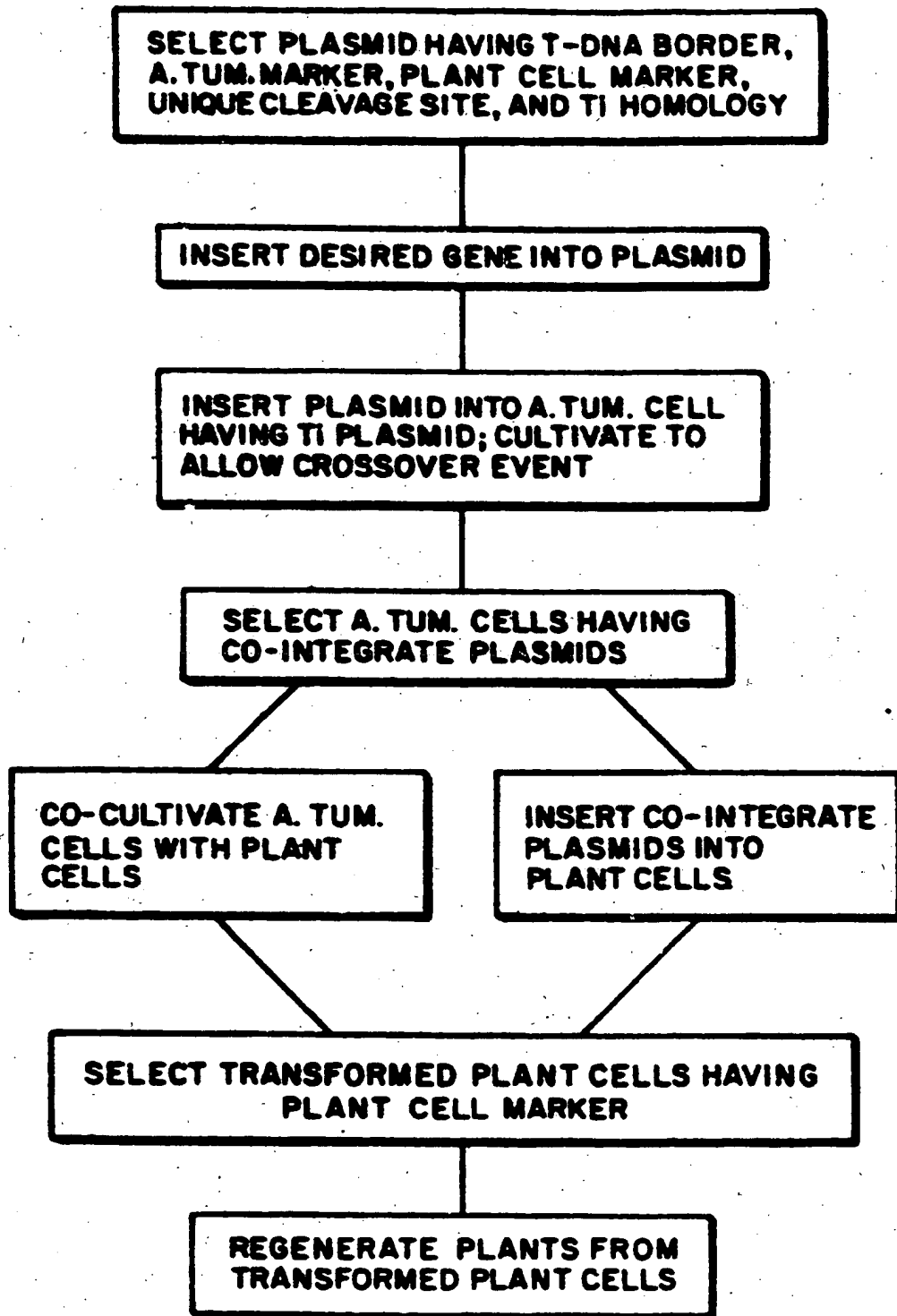
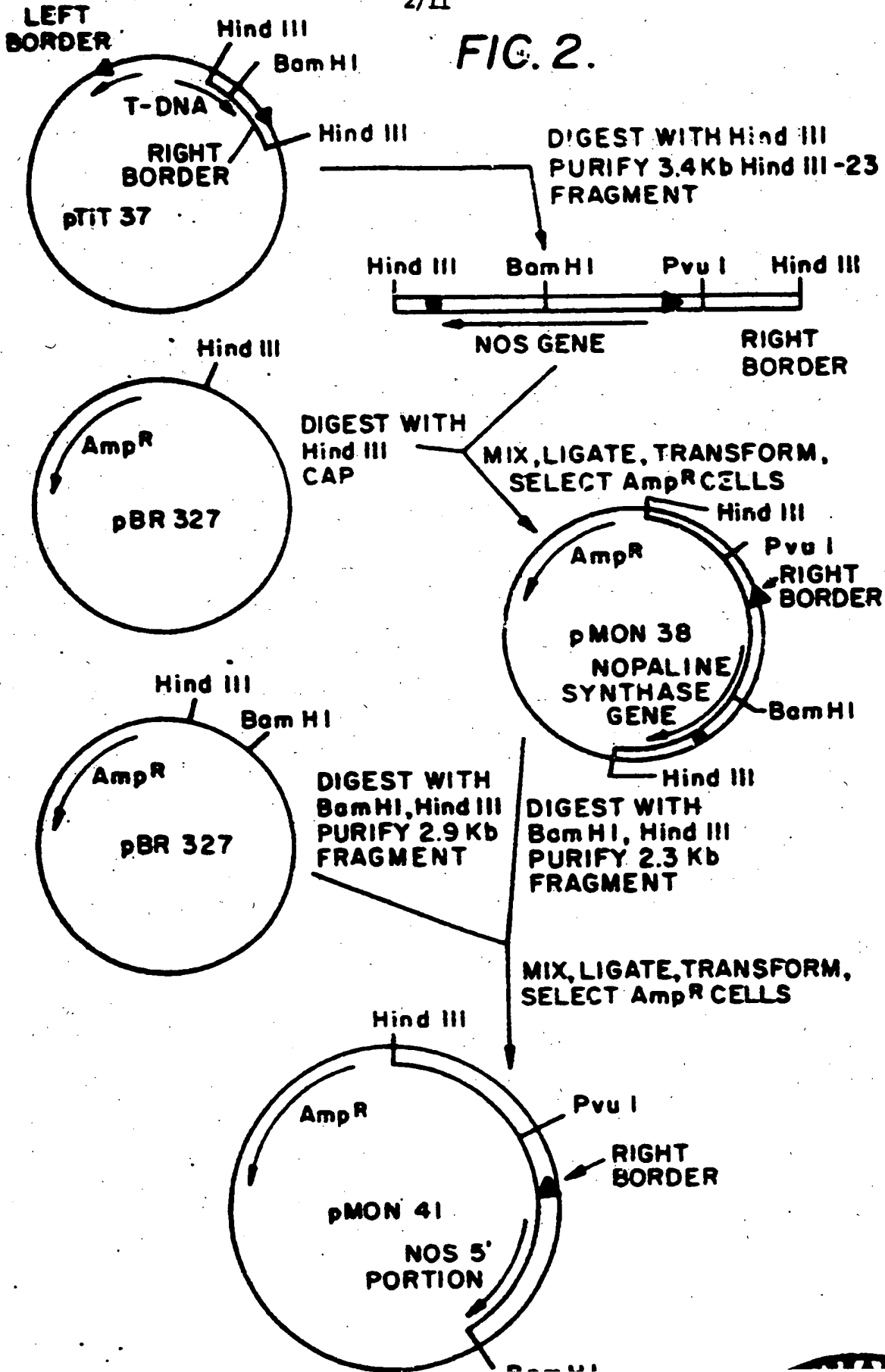
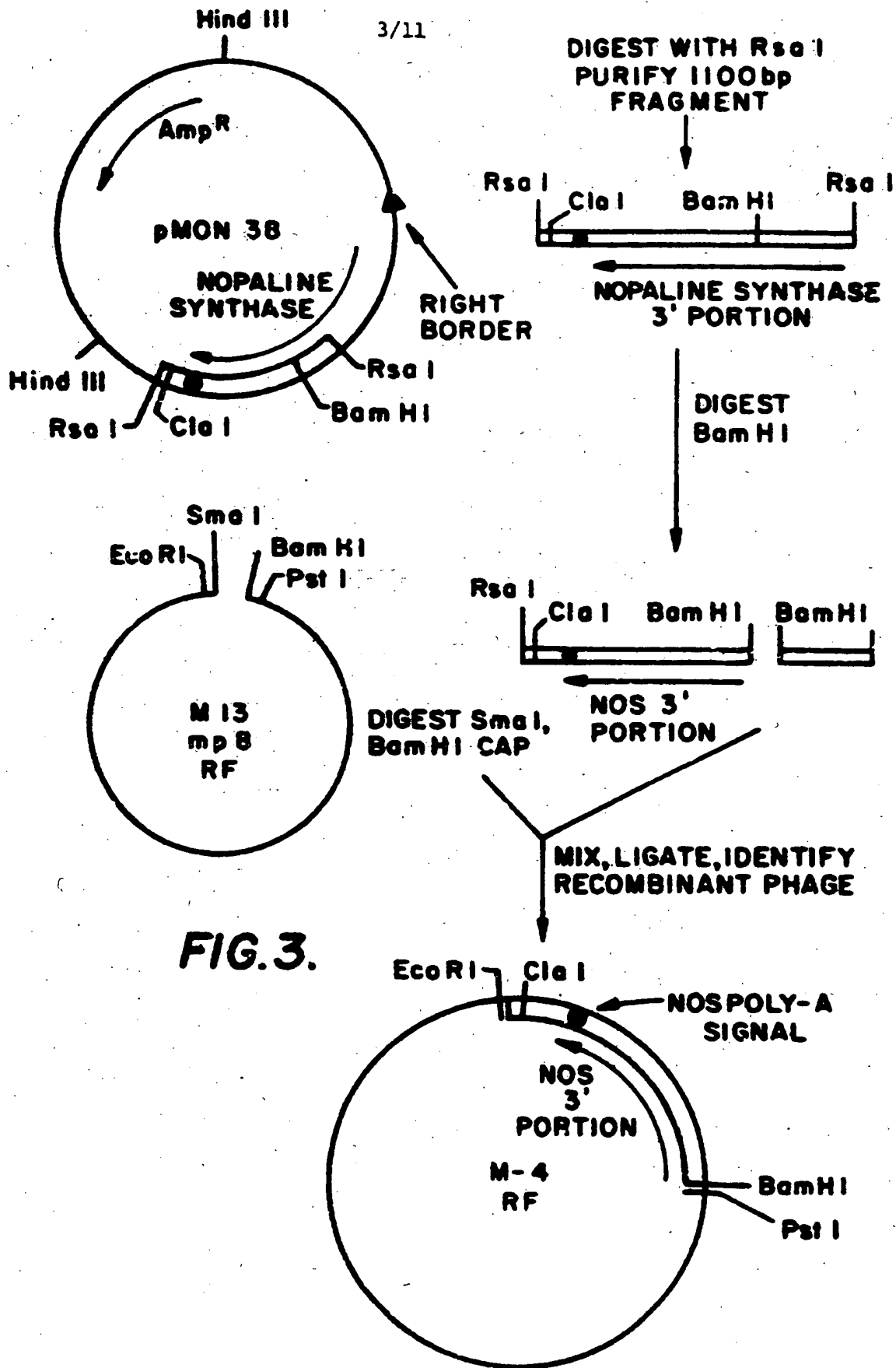

FIG. 1.

2/11

FIG. 2.





**FIG. 3.**

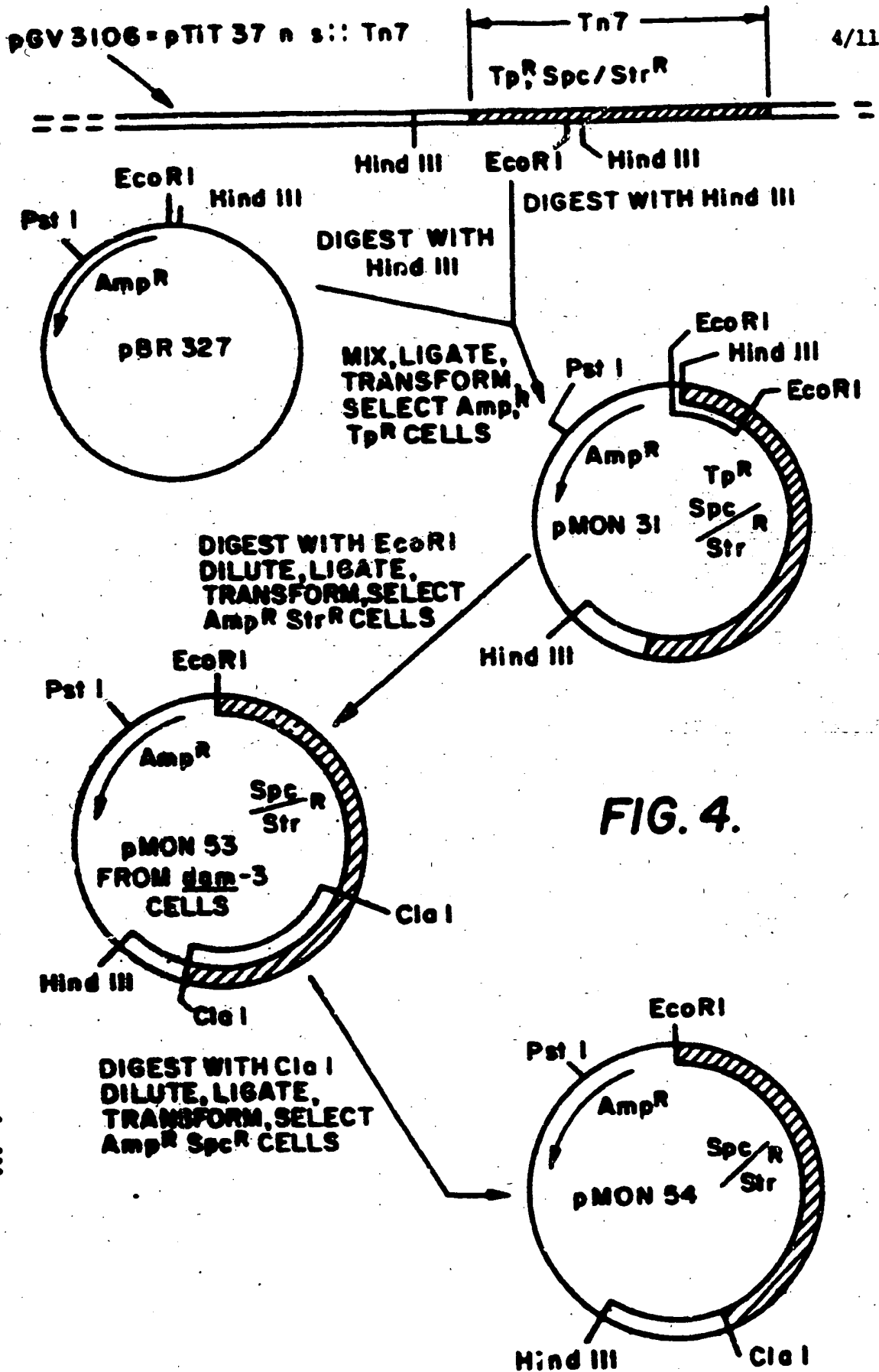



5/11

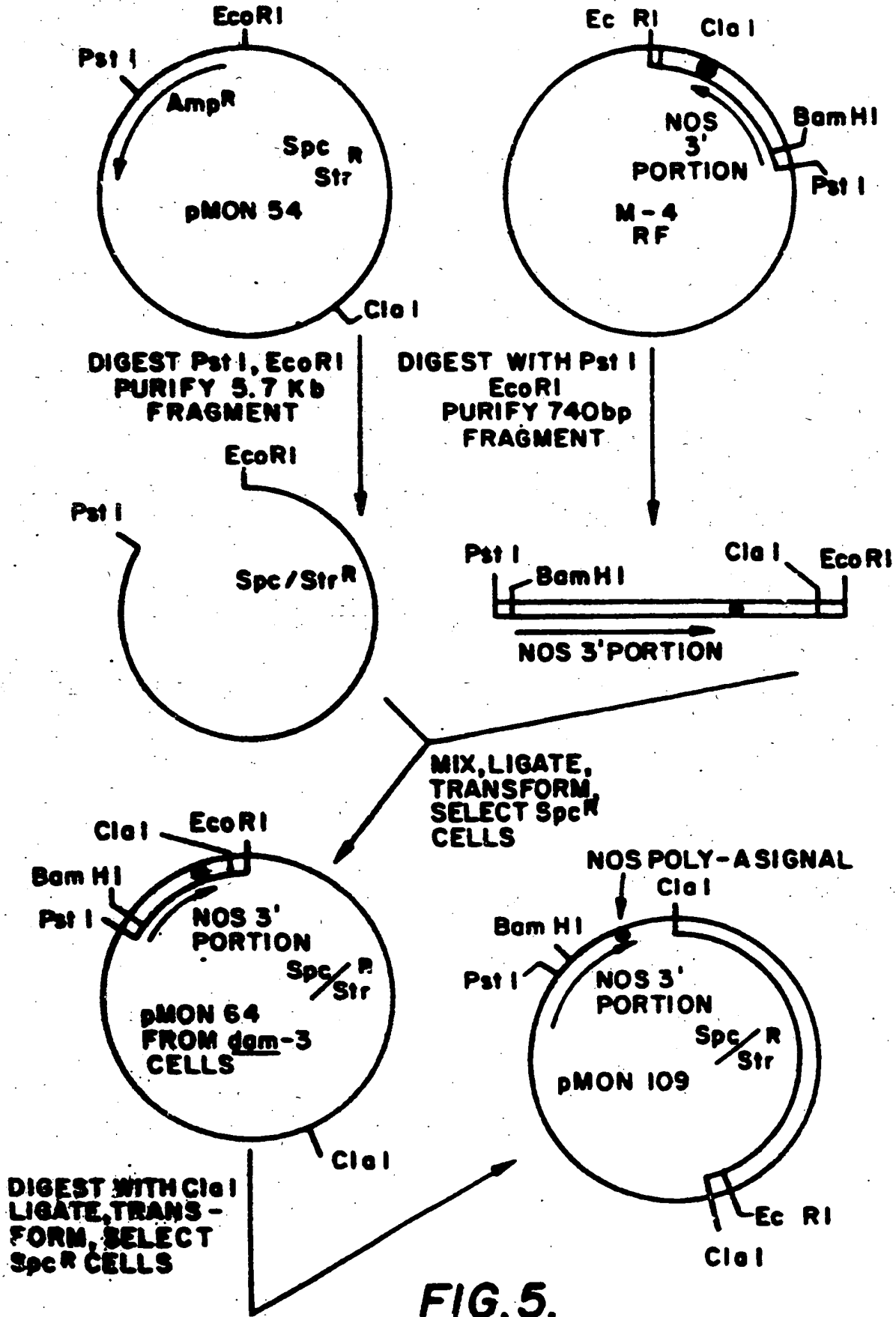

FIG. 5.

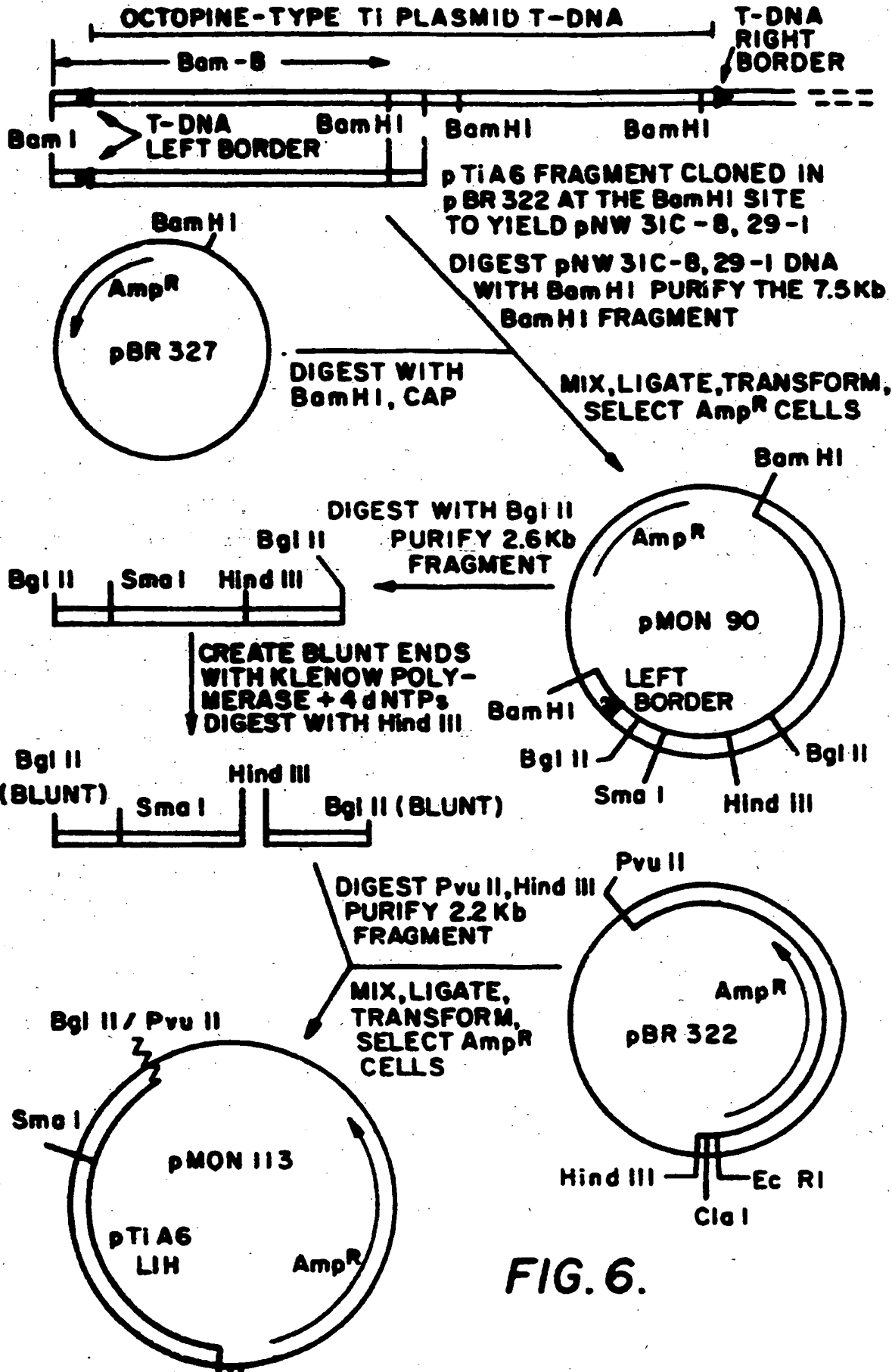
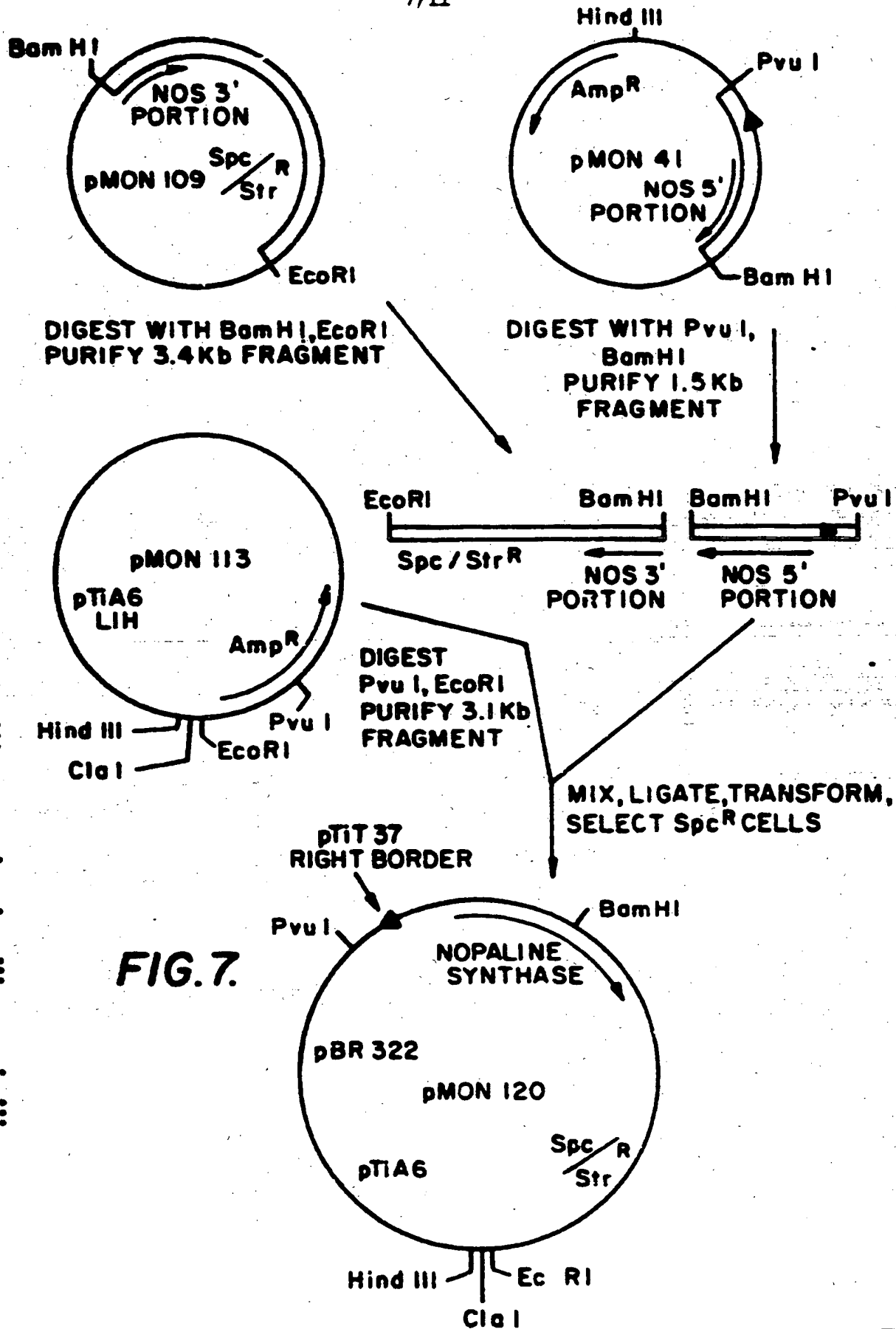

FIG. 6.

7/11



**FIG. 7.**

8/11

FIG. 8.

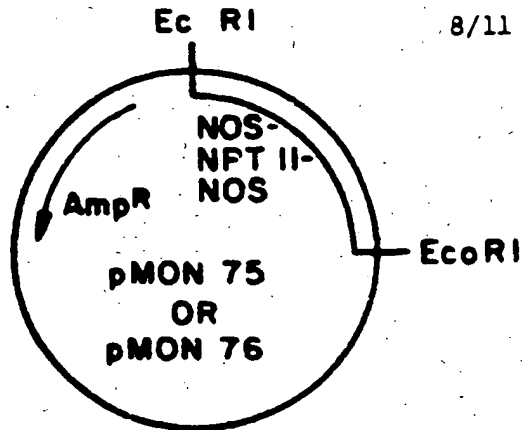

DIGEST WITH EcoRI  
PURIFY 1.5 Kb  
FRAGMENT

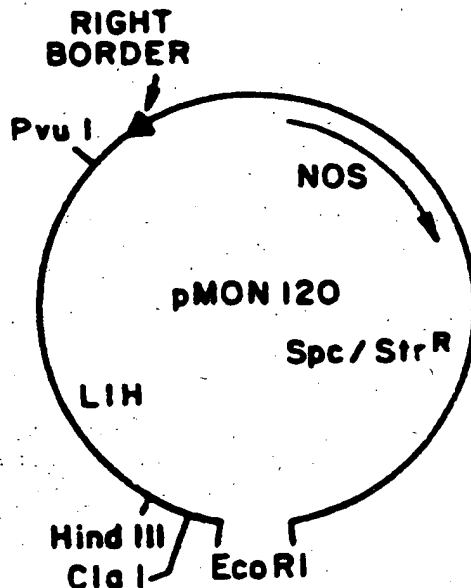
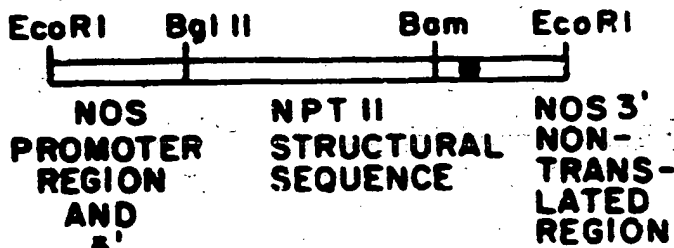

T4 DNA LIGASE  
TRANSFORM CELLS  
SELECT Spc<sup>R</sup> CELLS

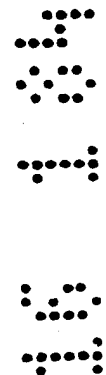
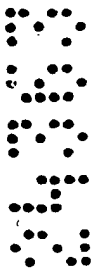
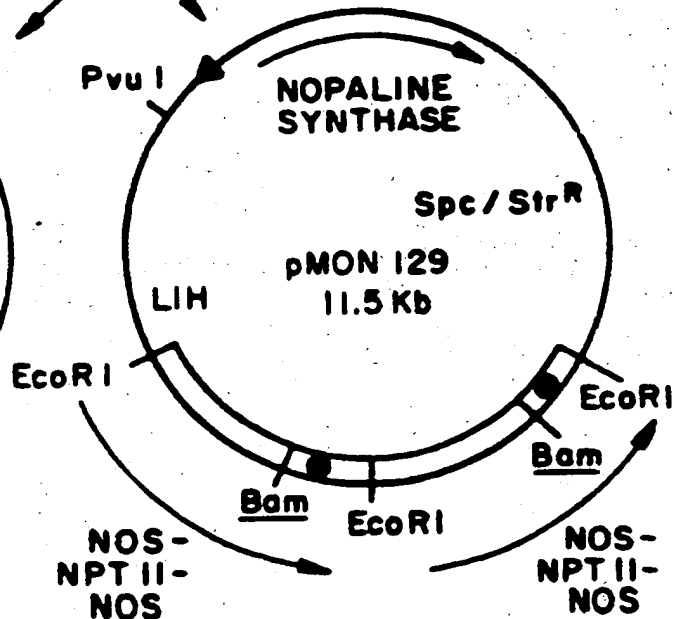
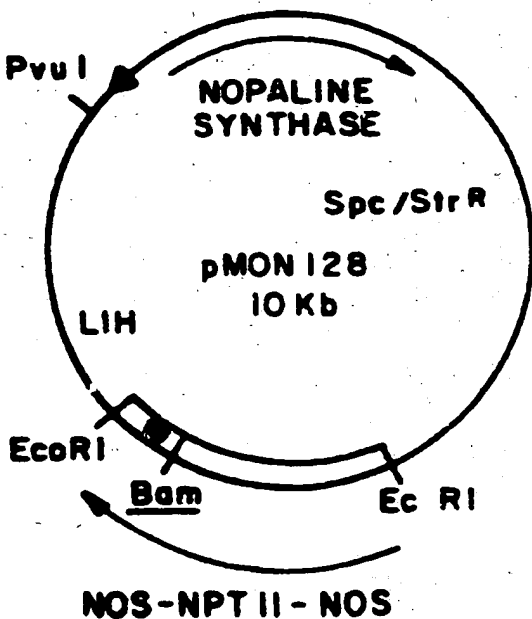

9/11

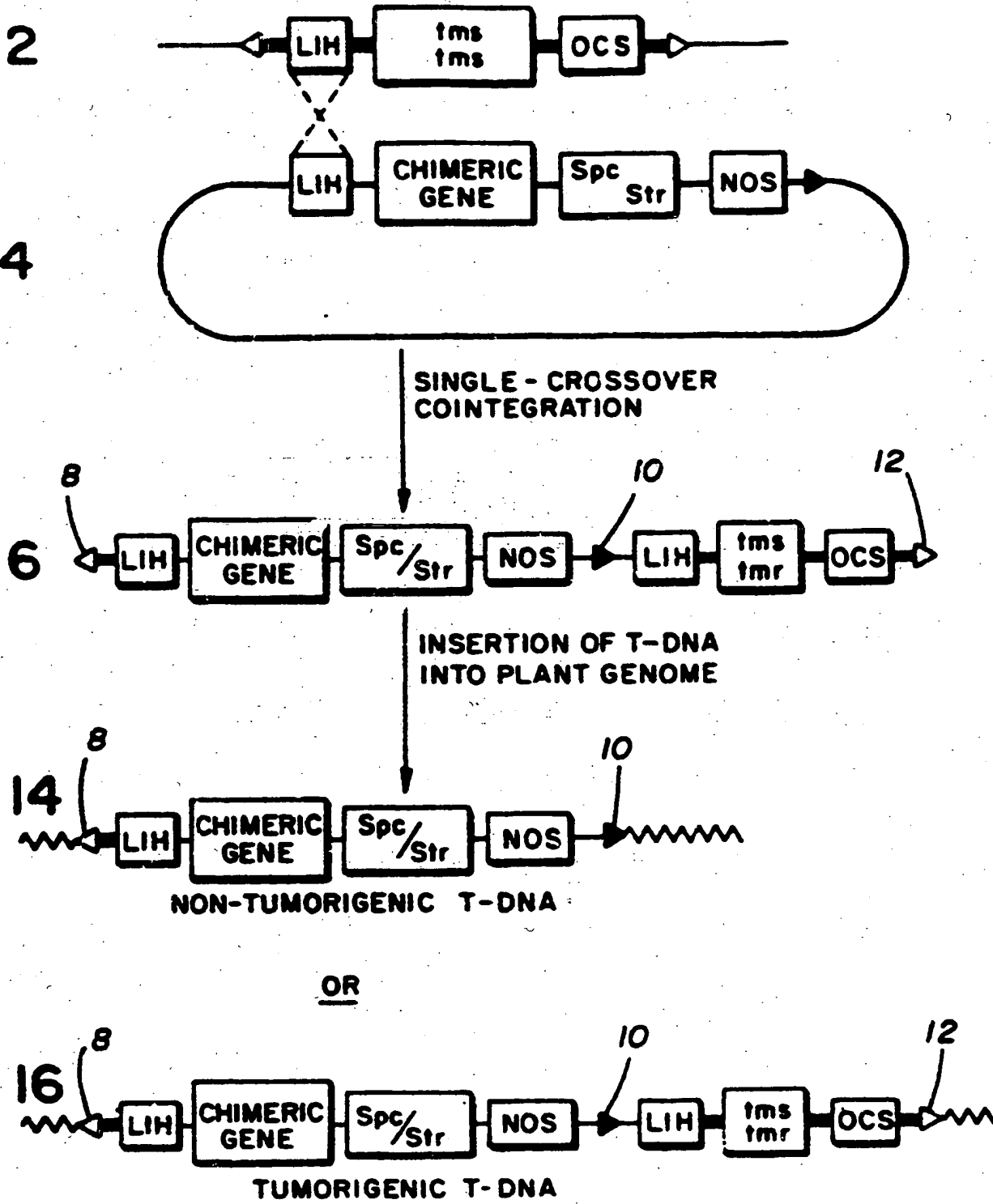

FIG. 9.

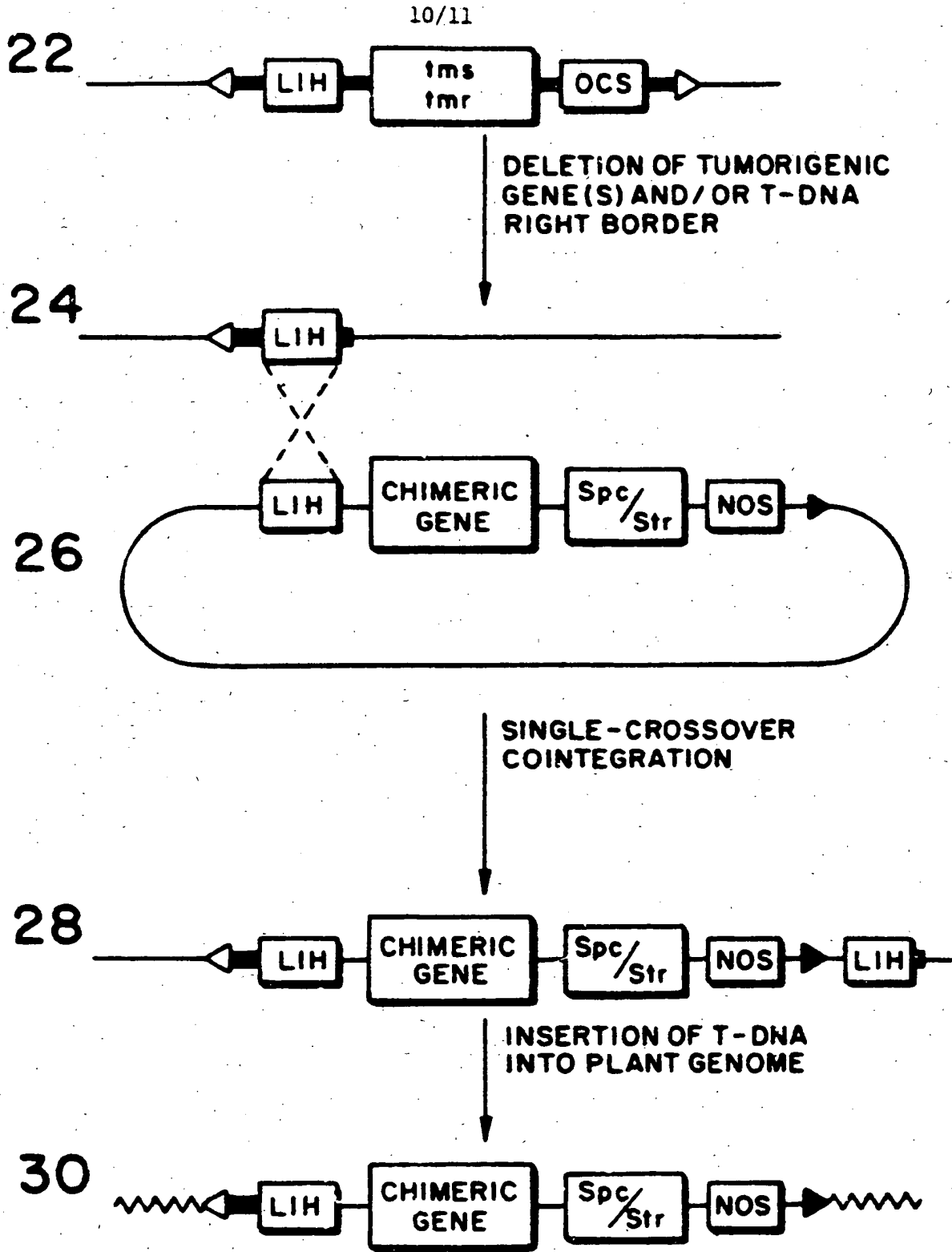

FIG.10.

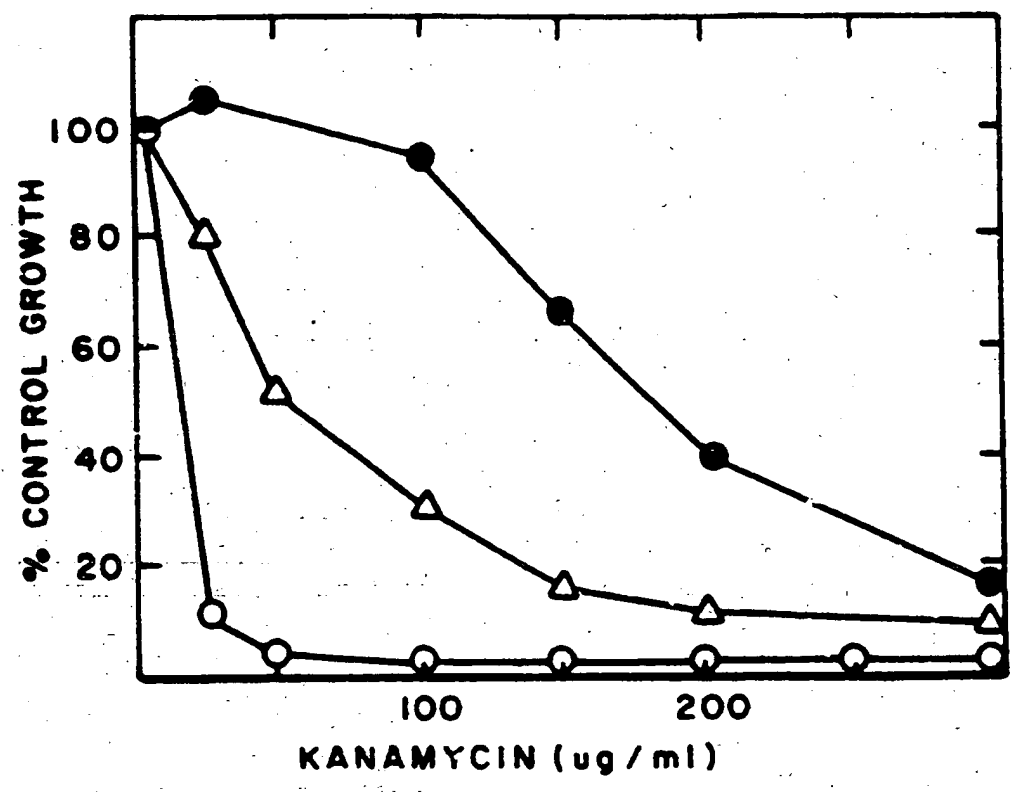

FIG. II.

# INTERNATIONAL SEARCH REPORT

PCT/US84/00050

International Application No.

<b>I. CLASSIFICATION OF SUBJECT MATTER</b> (If several classification symbols apply, indicate all)	
According to International Patent Classification (IPC) or to both National Classification and IPC	
INT. CL. C12N15/00, 5/00; C12P21/00; A01B79/00	
<b>II. FIELDS SEARCHED</b>	
Minimum Documentation Searched*	
Classification System:	Classification Symbols:
U.S.	435/172,240,68 47/1,58
Documentation Searched other than Minimum Documentation to the extent that such Documents are included in the Fields Searched:	
<b>III. DOCUMENTS CONSIDERED TO BE RELEVANT</b>	
Category:	Citation of Document, to which indicator, where appropriate, of the relevant passages:
X	N, Schell et al, Genetic Engineering to Biotechnology - The Critical Transition Edited by W.J. Whelan and Sandra Black Published by John Wiley and Sons Ltd. pages 41-52. 1-34
X	N, Otten et al, Mol. Gen. Genet. vol 183 pages 209-213 (1981) 15-21,23-26, 32-34
Y	N, Otten et al, Mol. Gen. Genet. vol 183 pages 209-213 (1981) 22,29-31
Y	N, Matzke et al, J. of Mol. Appl. Genet. vol no. 1 pages 39-49 (1981) 1-34
Y	N, Leemans et al, J. of Mol. Appl. Genet. pages 105-106 (1981)
* Special categories of cited documents:	
"A" document defining the current state of the art which is not considered to be of particular relevance	"T" later document published after the international filing date and not in connection with the international application but likely to understand the principle of the invention
"E" earlier document but published on or after the international filing date	"X" document of particular relevance, the claimed invention cannot be considered novel, or cannot be considered to involve an inventive step
"L" document which may have an effect on the prior art, or which is relevant to the state of the art, but whose citation or other use is not intended	"Y" document of particular relevance, the claimed invention cannot be considered novel, or cannot be considered to involve an inventive step, but the document is combined with one or more other such documents, such combination being obvious to a person skilled in the art
"O" document referring to an oral disclosure, use, exhibition or other means	"Z" document member of the same patent family
"P" document published prior to the international filing date but later than the priority date claimed	

**IV. CERTIFICATION**

Date of the Actual Completion of the International Search:

Date of Making of this International Search Report:

MARCH 14, 1984

21 MAR 1984

International Searching Authority:  
ISA/US

Signature of Authorized Officer:  
ALVIN E. TANENHOLZ *AE*



COMMONWEALTH OF AUSTRALIA

PATENTS ACT 1952

REGULATION 12(2)

FORM 8

RK

DECLARATION IN SUPPORT OF A CONVENTION APPLICATION  
~~UNDER PART XVI~~ FOR A PATENT OR PATENT OF ADDITION.

RU

In support of the Convention Application made ~~under Part XVI of the Patents Act 1952~~ by MONSANTO COMPANY for a patent for an invention entitled  
GENETICALLY TRANSFORMED PLANTS

I, John Elmer Maurer, General Patent Counsel, Monsanto Company, of 800 North Lindbergh Boulevard, St. Louis, 63167, in the State of Missouri, United States of America, do solemnly and sincerely declare as follows:

1. I am authorized by MONSANTO COMPANY, the applicant for the Patent to make this declaration on its behalf.

2. The basic application as defined by Section 141 of the Act was made at the Patent Office, Washington, District of Columbia, in the United States of America on the 17th of January 1983, by Robert Thomas Fraley, Robert Bruce Horsch and Stephen Gary Rogers.

3. Robert Thomas Fraley, 828 Lisakay Drive, Glendale, Missouri 63167, U.S.A.; Robert Bruce Horsch, 12316 Tempo Drive, St. Louis, Missouri 63141, U.S.A.; and Stephen Gary Rogers, 312 Sylvester Avenue, Webster Groves, Missouri 63119, United States of America,

RN

~~are~~ the actual inventor(s) of the invention, and the facts upon which the MONSANTO COMPANY is entitled to make the application are as follows: The Company is the assignee of the actual inventor(s).

4. The basic application referred to in paragraph 2 of this declaration was the first application made in a Convention country in respect of the invention, the subject of the application.

DECLARED at St. Louis, Missouri, aforesaid this 5th day of January, 19 84.

*John Elmer Maurer*  
JOHN ELMER MAURER

To Commissioner of Patents  
COMMONWEALTH OF AUSTRALIA

(12) AUSTRALIAN PATENT ABRIDGMENT  
(19) AU

(11) AU-B-24363/84

(54) GENETICALLY TRANSFORMED PLANTS

(71) MONSANTO COMPANY

(87) WO 84/02920

(21) 24363/84

559562

(22) 16.1.84

(24) 17.1.83

(31) 458402

(32) 17.1.84

(33) US

(43) 13.9.84

(44) 12.3.87

(51)<sup>3</sup>

C12N 15/00  
C12R 1/01

A01H 1/06  
C12N 5/02

C07G 17/00  
A01G 7/00

C12N 1/20

(72) ROBERT THOMAS FRALEY, ROBERT BRUCE HORSCH AND STEPHEN GARY ROGERS

(74) WE

(56) 23274/84  
31894/84  
33018/84

546542

C12N 15/00

(57) Claim

1. A method of creating transformed plant cells, comprising the following steps:

- a) culturing a microorganism containing a first plasmid containing at least one first gene that is expressed in plant cells and at least one second gene which serves as a marker in a selected microorganism and a Ti second plasmid, under conditions which allow the first plasmid to recombine with the Ti second plasmid in the microorganism, thereby creating a third plasmid having at least one T-DNA border on each side of the first genes, said genes being located in said first plasmid between a region of homology from the T-DNA region of the Ti plasmid and a T-DNA border;

- b) selecting those microorganisms containing the third plasmid;
- c) inserting the third plasmid, or a portion thereof, into plant cells; and
- d) culturing the plant cells under conditions which allow a segment of DNA from the third plasmid to be inserted into the genome of the plant cells.

13. A method of transforming plant cells, comprising inserting into the plant cells a co-integrate plasmid, or a portion thereof, which was formed by a single cross-over event between a first plasmid and a Ti second plasmid, wherein the co-integrate plasmid contains a region comprising:

- a) a first T-DNA border;
- b) a gene which is expressed in plant cells; and
- c) a second T-DNA border which is complementary to the first T-DNA border,

wherein the region does not contain any sequences which would render the plant cells incapable of being regenerated into morphologically normal plants.

15. Plant cells transformed by the method of any one of Claims 1 to 12 which contain a foreign gene which is expressed.